

**TENTATIVE GUIDELINES  
FOR THE DESIGN  
OF  
FLEXIBLE PAVEMENTS**



**INDIAN ROADS CONGRESS  
2012**



Digitized by the Internet Archive  
in 2014

[https://archive.org/details/govlawiracy2012sp37\\_0](https://archive.org/details/govlawiracy2012sp37_0)

**TENTATIVE GUIDELINES  
FOR THE DESIGN  
OF  
FLEXIBLE PAVEMENTS**

*Published by:*

**INDIAN ROADS CONGRESS**

Kama Koti Marg,  
Sector-6, R.K. Puram,  
New Delhi-110 022

**December 2012**

*Price : ₹ 600/-*

*(Plus Packing & Postage)*

IRC:37-2012

Edition in December 2012

Reprinted : June, 2013

*(All Rights Reserved. No part of this publication shall be reproduced, translated or transmitted in any form or by any means without the permission of the Indian Roads Congress)*

Printed at: India Offset Press, New Delhi  
(1000 Copies)

## CONTENTS

		Page No.
	Personnel of Highways Specifications and Standards Committee	(i)
1.	Introduction	1
2.	Scope of Guidelines	3
3.	General	4
4.	Traffic	5
	4.1 General	5
	4.2 Traffic Growth Rate	6
	4.3 Design Life	6
	4.4 Vehicle Damage Factor	7
	4.5 Distribution of Commercial Traffic Over the Carriageway	8
	4.6 Computation of Design Traffic	9
5.	Subgrade	10
	5.1 Requirements of CBR for Sub-grade	10
	5.2 Effective CBR	11
	5.3 Determination of Resilient Modulus	12
6.	Principles of Pavement Design	12
	6.1 Pavement Model	12
	6.2 Fatigue in Bottom Layer of Bituminous Pavement	13
	6.3 Rutting in Pavement	14
	6.4 Top Down Cracking in Bituminous Layer	15
	6.5 Cementitious Sub-base and Base	15
7.	Pavement Composition	17
	7.1 General	17
	7.2 Sub-base Layer	18
	7.3 Base Layer	20
	7.4 Bituminous Layer	22
8.	Perpetual Pavement	23
9.	Pavement Design Procedure	23
	9.1 Using IITPAVE	23
	9.2 Using Design Catalogue	24
	9.3 Material Properties	24

10.	Pavement Design Catalogues	24
10.1	Granular Base and Granular Sub-base	25
10.2	Cemented Base and Cemented Sub-base with Crack Relief Interlayer of Aggregate	29
10.3	Cemented Base and Cemented Sub-base with SAMI at the Interface of Cemented Base and the Bituminous Layer	32
10.4	Foamed Bitumen/bitumen Emulsion Treated RAP	35
10.5	Cemented Base and Granular Sub-base with Crack Relief Layer of Aggregate Interlayer	38
10.6	Other Pavement Composition	41
11.	Internal Drainage in Pavement	43
12.	Design in Frost Affected Areas	46
13.	Summary of Design Procedure and Use of IITPAVE Software	46
Annex-I :	Consideration in Design of Bituminous Pavement	49
Annex-II :	Worked out Examples Illustrating the Design Method	57
Annex-III :	Equivalence of Thickness of Bituminous Mixes of Different Moduli	65
Annex-IV :	Preparation of Laboratory Test Specimens for CBR Test and Selection of Sub-grade CBR	66
Annex-V:	Drainage Layer	70
Annex-VI :	Recommendation for Bituminous Wearing Courses for Flexible Pavement	72
Annex-VII :	Selection of Grade of Binders and Mixes for Bituminous Courses	74
Annex-VIII :	Resilient Modulus of Granular Materials	75
Annex-IX :	Reclaimed Asphalt Pavement and Mix Design	76
Annex-X :	Pavement Layers with Chemical Stabilized Materials	83
Annex-XI :	Roads Constructed in India with Alternate Materials	89
	References	90

## PERSONNEL OF THE HIGHWAYS SPECIFICATIONS AND STANDARDS COMMITTEE

(As on 23<sup>rd</sup> September, 2011)

- |                |                                    |  |
|----------------|------------------------------------|--|
| 1.             | Indoria, R.P.<br>(Convenor)        | Director General (Road Development) & Spl. Secretary,<br>Ministry of Road Transport & Highways, New Delhi      |
| 2.             | Kandasamy, C.<br>(Co-Convenor)     | Addl. Director General, Ministry of Road Transport &<br>Highways, New Delhi                                    |
| 3.             | Kumar, Manoj<br>(Member-Secretary) | Chief Engineer (R) SR&T, Ministry of Road Transport &<br>Highways, New Delhi                                   |
| <b>Members</b> |                                    |  |
| 4.             | Alam, Parwez                       | Vice-President, Hindustan Constrn. Co. Ltd., Mumbai  |
| 5.             | Basu, S.B.                         | Chief Engineer (Retd.) MoRT&H, New Delhi   |
| 6.             | Bongirwar, P.L.                    | Advisor, L&T, Mumbai   |
| 7.             | Bordoloi, A.C.                     | Chief Engineer (NH) Assam, Guwahati  |
| 8.             | Chandrasekhar, Dr. B.P.            | Director (Tech.), National Rural Roads Development Agency,<br>(Ministry of Rural Development), New Delhi       |
| 9.             | Datta, P.K.                        | Executive Director, Consulting Engg. Services (I) Pvt. Ltd.,<br>New Delhi                                      |
| 10.            | Gangopadhyay, Dr. S.               | Director, Central Road Research Institute, New Delhi   |
| 11.            | Gupta, D.P.                        | Director General (RD) & AS (Retd.), MoRT&H, New Delhi  |
| 12.            | Gupta, K.K.                        | Chief Engineer (Retd.), Haryana PWD, Faridabad   |
| 13.            | Jain, R.K.                         | Chief Engineer (Retd.) Haryana PWD, Sonapat  |
| 14.            | Jain, Dr. S.S.                     | Professor & Coordinator, Centre of Transportation Engg.,<br>IIT Roorkee  |
| 15.            | Jain, N.S.                         | Chief Engineer (Retd.), MoRT&H, New Delhi  |
| 16.            | Kadiyali, Dr. L.R.                 | Chief Executive, L.R. Kadiyali & Associates, New Delhi   |
| 17.            | Katare, P.K.                       | Director (Project-III), National Rural Roads Development<br>Agency, (Ministry of Rural Development), New Delhi |
| 18.            | Krishna, Prabhat                   | Chief Engineer (Retd.) Ministry of Road Transport & Highways,<br>New Delhi                                     |
| 19.            | Kumar, Ashok                       | Chief Engineer (Retd.) Ministry of Road Transport & Highways,<br>New Delhi                                     |
| 20.            | Kumar, Mahesh                      | Engineer-in-Chief, Haryana PWD, Chandigarh   |



## IRC:37-2012

- |     |                       |   |
|-----|-----------------------|---|
| 21. | Kurian, Jose          | Chief Engineer, DTTDC Ltd., New Delhi                               |
| 22. | Momin, S.S.           | Former Member, Maharashtra Public Service Commission, Mumbai        |
| 23. | Nashkar, S.S.         | Chief Engineer (NH), PW (R) West Bengal, Kolkata                    |
| 24. | Patankar, V.L.        | Member (Tech.), National Highways Authority of India, New Delhi     |
| 25. | Pradhan, B.C.         | Chief Engineer (NH), PWD Orrisa, Bhubaneshwar                       |
| 26. | Prasad, D.N.          | Chief Engineer (NH), RCD, Patna                                     |
| 27. | Raju, Dr. G.V.S.      | Chief Engineer (R&B), PWD Andhra Pradesh, Hyderabad                 |
| 28. | Rathore, S.S.         | Principal Secretary to the Govt. of Gujarat, R&B Deptt. Gandhinagar |
| 29. | Reddy, Dr. T.S.       | Ex-Scientist, Central Road Research Institute, New Delhi            |
| 30. | Reddy, K. Siva        | Engineer-in-Chief (R&B), PWD Andhra Pradesh, Hyderabad              |
| 31. | Sharma, Dr. V.M.      | Consultant, AIMIL, New Delhi  |
| 32. | Sharma, S.C.          | Director General (RD) & AS (Retd.), MoRT&H, New Delhi               |
| 33. | Shukla, R.S.          | Ex-Scientist, Central Road Research Institute, New Delhi            |
| 34. | Singh, Nirmal Jit     | Director General (RD) & SS (Retd.), MoRT&H, New Delhi               |
| 35. | Sinha, A.K.           | Chief Engineer, (NH), UP PWD, Lucknow                               |
| 36. | Sinha, A.V.           | Director General (RD) & SS (Retd.) MoRT&H, New Delhi                |
| 37. | Singh, B.N.           | Member (Project), National Highways Authority of India, New Delhi   |
| 38. | Sinha, S.             | Addl. Chief Transportation Engineer, CIDCO, Navi Mumbai             |
| 39. | Yadav, Dr. V.K.       | Addl. Director General, DGBR, New Delhi                             |
| 40. | Chief Engineer (Plg.) | Ministry of Road Transport & Highways, New Delhi                    |

### ***Ex-Officio Members***

- |    |   |   |
|----|---|---|
| 1. | President, IRC  | (Yadav, Dr. V.K.), Addl. Director General, DGBR, New Delhi        |
| 2. | Director General (RD) & Spl. Secretary/<br>Secretary General, IRC | (Indoria, R.P.), Ministry of Road Transport & Highways, New Delhi |

### ***Corresponding Members***

- |    |                   |  |
|----|-------------------|--|
| 1. | Justo, Dr. C.E.G. | Emeritus Fellow, Bangalore University, Bangalore   |
| 2. | Khattar, M.D.     | Consultant, Runwal Centre, Mumbai                  |
| 3. | Agarwal, M.K.     | Engineer-in-Chief (Retd.), Haryana PWD             |
| 4. | Borge, V.B.       | Secretary (Roads) (Retd.), Maharashtra PWD, Mumbai |



## ABBREVIATIONS

All symbols are explained where they occur first. Some of the symbols are,

AAAT	-	Average Annual Air Temperature
AAPT	-	Average Annual Pavement Temperature
AMAT	-	Average Monthly Air Temperature
AMPT	-	Average Monthly Pavement Temperature
AASHTO	-	American Association of State Highway and Transportation Officials
ASTM	-	American Society of Testing and Materials
AUSTROADS	-	Association of Australian and New Zealand Road Transport and Traffic Authorities.
BC	-	Bituminous Concrete
BIS	-	Bureau of Indian Standards
BM	-	Bituminous Macadam
$C_s$	-	Spacing of Transverse Cracks
CBR	-	California Bearing Ratio
CFD	-	Cumulative Fatigue Damage
CTB/CT	-	Cement Treated Base - includes all type of Cement/Chemical stabilized bases
DBM	-	Dense Bituminous Macadam
E	-	Elastic Modulus of Cementitious Layer
GB	-	Granular Base
GDP	-	Gross Domestic Product
GSB	-	Granular Sub-base
$I_c$	-	Crack Infiltration Rate Per Unit Length
IRC	-	Indian Roads Congress
$K_p$	-	Infiltration Rate Per Unit Area of Un-Cracked Pavement Surface
$M_R$	-	Resilient Modulus
$M_{RUP}$	-	Modulus of Rupture
MEPDG	-	Mechanistic Empirical Pavement Design Guide
msa	-	Million Standard Axles

MORTH	-	Ministry of Road Transport & Highways
MSS	-	Mixed Seal Surfacing
$N_c$	-	No. of Longitudinal Cracks
$N_f$	-	Cumulative No. of Repetitions for Fatigue Failure
$N_R$	-	Cumulative No. of Repetitions for Rutting Failure
PC	-	Premix Carpet
$q_i$	-	Water Infiltration Rate Per Unit Area
SAMI	-	Stress Absorbing Membrane Interlayer
RAP	-	Reclaimed Asphalt Pavement
RF	-	Reliability Factor
SDBC	-	Semi-Dense Bituminous Concrete
SD	-	Surface Dressing
SDP	-	State Domestic Product
UCS	-	Unconfined Compressive Strength
$V_a$	-	Volume of Air Voids
$V_b$	-	Volume of Bitumen
VDF	-	Vehicle Damage Factor
VG	-	Viscosity Grade
$W_p$	-	Width of Pavement Subjected to Infiltration
$W_c$	-	Length of Transverse Cracks
WBM	-	Water Bound Macadam
WMM	-	Wet Mix Macadam
$\epsilon_t$	-	Horizontal Tensile Strain
$\epsilon_v$	-	Vertical Subgrade Strain
$\mu$	-	Poisson's Ratio
$\mu\epsilon$	-	Micro Strain

# TENTATIVE GUIDELINES FOR THE DESIGN OF FLEXIBLE PAVEMENTS

## 1 INTRODUCTION

**1.1** The guidelines on design of flexible pavement were first brought out in 1970, which were based on California Bearing Ratio (CBR) of subgrade and traffic in terms of number of commercial vehicles (more than 3 tonnes laden weight). These guidelines were revised in 1984 in which design traffic was considered in terms of cumulative number of equivalent standard axle load of 80 kN in millions of standard axles (msa) and design charts were provided for traffic up to 30 msa using an empirical approach.

**1.2** The guidelines were revised again in 2001 when pavements were required to be designed for traffic as high as 150 msa. The revised guidelines used a semi-mechanistic approach based on the results of the MORTH's research scheme R-56 implemented at IIT Kharagpur. The software, FPAVE was developed for the analysis and design of flexible pavements. Multilayer elastic theory was adopted for stress analysis of the layered elastic system. A large number of data collected from different parts of India under various research schemes of MORTH were used for the development of fatigue and rutting criteria from field performance data.

**1.3** The traffic pattern has changed since then and so has the technology. The volume of tandem, tridem and multi-axle vehicles has increased manifold and heavier axle loads are common. Experience has been gained on the use of new form of construction and materials such as stone matrix asphalt, modified bitumen, foamed bitumen, bitumen emulsion, warm asphalt, cementitious bases and sub-bases since the publication of the last revision of the guidelines. Conventional as well as commercially available chemical soil stabilizers are being successfully used in trial sections. Attention is focused on fatigue resistant bituminous mixes with high viscosity binders for heavy traffic with a view to construct high performance long life bituminous pavements. The guidelines contained in this document reflect the current knowledge in the subject.

**1.4** Conventional construction material like aggregates is becoming progressively scarce on account of environmental concerns as well as legal restrictions on quarrying while the construction activity has expanded phenomenally. This has shifted focus from large scale use of conventional aggregates to use of local, recycled and engineered marginal aggregates in construction.

**1.5** It is recognized that research as well as performance trials have not been very extensive in India for some of the new materials but these have been included in the guidelines in the light of extensive performance reports and current practice in Australia, South Africa and other countries with due safeguards in design for heavy axle loads. Some trials in India have performed well (**Annex XI**).

Accordingly, this guidelines of IRC:37 incorporates some of the new and alternate materials in the current design practices. A designer can use his sound engineering judgment consistent with local environment using a semi-mechanistic approach for design of pavements.

**1.6** The initial draft was prepared by Prof. B.B. Pandey of IIT Kharagpur and presented before the Flexible Pavement Committee (H-2) of IRC during its meeting held on 4.6.2011. There after the draft, after further revision, was presented at the joint meeting of Flexible Pavement Committee and Composite Pavement Committee (H-9) under the joint convenorship of Shri A.V. Sinha and Shri P.L. Bongirwar held on 12.9.2011 and the draft was finally approved in the joint meeting. The name of the personnel of Flexible Pavement Committee (H-2) are given below:

Sinha, A.V.	-	Convenor
Bose, Dr. Sunil	-	Co-Convenor
Nirmal, S.K.	-	Member-Secretary

***Members***

Basu, Chandan	Katare, P.K.
Bhanwala, Col. R.S.	Krishna, Prabhat
Bongirwar, P.L.	Lal, Chaman
Das, Dr. Animesh	Nigam, Dr. S.K.
Dushaka, Vanlal	Pachauri, D.K.
Gajria, Maj. Gen. K.T.	Pandey, R.K.
Jain, Dr. M.C.	Sarma, Dr. Sivaram B.
Jain, R.K.	Sharma, S.C.
Jain, Rajesh Kumar	Tyagi, B.R.
Jain, Dr. S.S.	Wasson, Ashok
Kandhal, Prof. Prithvi Singh	Yadav, Dr. V.K. (Rep. of DGBR)

***Corresponding Members***

Bhattacharya, C.C.	Justo, Dr. C.E.G.
Dongre, Dr. Raj	Sharma, S.K.

***Ex-Officio Members***

President, IRC	(Yadav, Dr. V.K., VSM)
Director General (RD) & SS, MORTH/ Secretary General, IRC	(Indoria, R.P.)

**1.7** The finalized document was submitted to the Highways Specifications and Standards Committee (HSS) of IRC for their consideration. The document was approved



by the Highways Specifications and Standards Committee (HSS) in its meeting held on 23.9.2011. The Executive Committee in its meeting held on 7.10.2011 approved the document for placing before Council. The document was approved by the IRC Council in its meeting held on 3.11.2011 at Lucknow. The DG (RD) & SS authorized the Convenor of the Flexible Pavement Committee (H-2) to incorporate the comments offered by the Council members. The comments have been incorporated and the document has been finalized as one of the revised Publications of IRC.

## 2 SCOPE OF THE GUIDELINES

**2.1** The Guidelines shall apply to the design of new flexible pavements for Expressways, National Highways, State Highways, Major District Roads and other categories of roads predominantly carrying motorized vehicles. These guidelines do not form a rigid standard and sound engineering judgment considering the local environment and past pavement performance in the respective regions should be given due consideration while selecting a pavement composition.

**2.2** For the purpose of the guidelines, flexible pavements include pavements with Bituminous surfacing over:

- (i) Granular base and sub-base
- (ii) Cementitious bases and sub-bases with a crack relief layer of aggregate interlayer below the bituminous surfacing
- (iii) Cementitious bases and sub-bases with SAMI in-between bituminous surfacing and the cementitious base layer for retarding the reflection cracks into the bituminous layer
- (iv) Reclaimed Asphalt Pavement (RAP) with or without addition of fresh aggregates treated with foamed bitumen/bitumen emulsion

Use of deep strength long life bituminous pavement is also included.

**2.3** These guidelines shall not be straightway applied to overlay design for which IRC:81-1997(31) or a more suitable procedure based on evaluation of in situ properties of pavement layers by Falling Weight Deflectometer (FWD) should be used (25,56).

**2.4** The guidelines may require revision from time to time in the light of future developments and experience in the field. Towards this end, it is suggested that all the organizations intending to use the guidelines should keep a detailed record of the year of construction, subgrade CBR, soil characteristics including resilient modulus, pavement composition and specifications, traffic, pavement performance, overlay history, climatic conditions etc. and provide feedback to the Indian Roads Congress for further revision.

### 3 GENERAL

**3.1** The IRC:37-2001 was based on a Mechanistic Empirical approach, which considered the design life of pavement to last till the fatigue cracking in bituminous surface extended to 20 per cent of the pavement surface area or rutting in the pavement reached the terminal rutting of 20 mm, whichever happened earlier. The same approach and the criteria are followed in these revised guidelines as well, except that the cracking and rutting have been restricted to 10 per cent of the area for design traffic exceeding 30 million standard axles. The cracking and rutting models in IRC: 37-2001 were based on the findings of the research schemes of the Ministry of Road Transport & Highways, Government of India, under which pavement performance data were collected from all over India by academic institutions and Central Road Research Institute to evolve the fatigue and rutting criteria for pavement design using a semi-analytical approach. In the absence of any further research in the field to modify or refine these models, the same models are considered applicable in these guidelines as well. These revised guidelines, however, aim at expanding the scope of pavement design by including alternate materials like cementitious and reclaimed asphalt materials, and subjecting them to analysis using the software IITPAVE, a modified version of FPAVE developed under the Research Scheme R-56 for layered system analysis. The material properties of these alternate materials, such as Resilient/Elastic Modulus, were extensively tested in laboratories in the country, especially IIT, Kharagpur. Conservative values of material properties are suggested in these Guidelines because of variation in test results on materials from different sources and based on National Standards of Australia, South Africa and MEPDG of the USA as well as those adopted in some of the satisfactorily performing pavements constructed in the country using cementitious and RAP bases (Ref. **Annex XI**). The material properties should be tested in laboratory as per test procedures recommended in **Annex IX** and **X**.

**3.2** The experience on a number of high volume highways designed and constructed during the last decade using the guidelines of IRC: 37-2001 as reported in various literature shows that the most common mode of distress has been flushing and rutting in the bituminous layer (49, 51 and 61). Surface cracking of the bituminous layer (i.e. the top down cracking) within a year or two of traffic loading is also reported from different parts of India (39, 53 and 63). Heavy Vehicle Simulator at the Central Road Research Institute exhibited similar surface cracking. Published literatures on fatigue and rutting of different types of bituminous mixes have helped in better understanding of these problems (20, 24, 27, 38, 42, 43, 47 and 51). The present guidelines strongly recommend that these problems need serious consideration. Bituminous mix design needs to be considered an integral part of pavement design exercise with a view to provide (i) fatigue resistant mixes in the bottom bituminous layer to eliminate bottom-up cracking (ii) rut resistant bituminous layers of high tensile strength to eliminate rutting and surface cracking.

**3.3** The guidelines also recommend cementitious sub-bases and bases. Such bound layers would display shrinkage and traffic induced cracks after the construction and the



long term effective moduli would be much lower than those determined in the laboratory by unconfined compression test. Elastic Moduli of such layers are to be judiciously selected, which can ensure long term performance as a structural layer in the pavement. Their fatigue fracture behaviour is analyzed on the same principles that are applied to concrete pavements. Only low strength cementitious bases are recommended for use since high strength rigid bases develop wide shrinkage cracks which reflect to the bituminous surface rapidly. Due to lower strength requirement of the cemented sub-bases and bases, the required compressive strength can be easily achieved even by stabilizing local and marginal materials. While their strength may be low, it is essential to ensure a reasonable level of durability by 'wetting' and 'drying' test.

**3.4** The Guidelines recommend that the following aspects should be given consideration while designing to achieve better performing pavements:

- (i) Incorporation of design period of more than fifteen years.
- (ii) Computation of effective CBR of subgrade for pavement design.
- (iii) Use of rut resistant surface layer.
- (iv) Use of fatigue resistant bottom bituminous layer.
- (v) Selection of surface layer to prevent top down cracking.
- (vi) Use of bitumen emulsion/foamed bitumen treated Reclaimed Asphalt Pavements in base course.
- (vii) Consideration of stabilized sub-base and base with locally available soil and aggregates.
- (viii) Design of drainage layer.
- (ix) Computation of equivalent single axle load considering (a) single axle with single wheel (b) single axle with dual wheels (c) tandem axle and (d) tridem axles.
- (x) Design of perpetual pavements with deep strength bituminous layer.

Each of the items listed above has been discussed in these guidelines at appropriate places.

**3.5** Load associated failure is considered as the mode of failure in these guidelines as environmental effects on bituminous layers are built-in in the calibration of rutting and fatigue equations from pavement performance.

## **4 TRAFFIC**

### **4.1 General**

**4.1.1** The recommended method considers design traffic in terms of the cumulative number of standard axles (80 kN) to be carried by the pavement during the design life. Axle load spectrum data are required where cementitious bases are used for evaluating the



fatigue damage of such bases for heavy traffic. Following information is needed for estimating design traffic:

- (i) Initial traffic after construction in terms of number of Commercial Vehicles per day (CVPD).
- (ii) Traffic growth rate during the design life in percentage.
- (iii) Design life in number of years.
- (iv) Spectrum of axle loads.
- (v) Vehicle Damage Factor (VDF).
- (vi) Distribution of commercial traffic over the carriageway.

**4.1.2** Only the number of commercial vehicles having gross vehicle weight of 30 kN or more and their axle-loading is considered for the purpose of design of pavement.

**4.1.3** Assessment of the present day average traffic should be based on seven-day-24-hour count made in accordance with IRC: 9-1972 "Traffic Census on Non-Urban Roads".

## **4.2 Traffic Growth Rate**

**4.2.1** The present day traffic has to be projected for the end of design life at growth rates ('r') estimated by studying and analyzing the following data:

- (i) The past trends of traffic growth; and
- (ii) Demand elasticity of traffic with respect to macro-economic parameters (like GDP or SDP) and expected demand due to specific developments and land use changes likely to take place during design life.

**4.2.2** If the data for the annual growth rate of commercial vehicles is not available or if it is less than 5 per cent, a growth rate of 5 per cent should be used (IRC:SP:84-2009).

## **4.3 Design Life**

**4.3.1** The design life is defined in terms of the cumulative number of standard axles in msa that can be carried before a major strengthening, rehabilitation or capacity augmentation of the pavement is necessary.

**4.3.2** It is recommended that pavements for National Highways and State Highways should be designed for a minimum life of 15 years. Expressways and Urban Roads may be designed for a longer life of 20 years or higher using innovative design adopting high fatigue bituminous mixes. In the light of experience in India and abroad, very high volume roads with design traffic greater than 200 msa and perpetual pavements can also be designed using the principles stated in the guidelines. For other categories of roads, a design life of 10 to 15 years may be adopted.

**4.3.3** If stage construction is adopted, thickness of granular layer should be provided for the full design period. In case of cemented bases and sub-bases, stage construction may lead to early failure because of high flexural stresses in the cemented layer and therefore, not recommended.

## 4.4 Vehicle Damage Factor

**4.4.1** The guidelines use Vehicle Damage Factor (VDF) in estimation of cumulative msa for thickness design of pavements. In case of cemented bases, cumulative damage principle is used for determining fatigue life of cementitious bases for heavy traffic and for that spectrum of axle loads is required.

**4.4.2** The Vehicle Damage Factor (VDF) is a multiplier to convert the number of commercial vehicles of different axle loads and axle configuration into the number of repetitions of standard axle load of magnitude 80 kN. It is defined as equivalent number of standard axles per commercial vehicle. The VDF varies with the vehicle axle configuration and axle loading.

**4.4.3** The equations for computing equivalency factors for single, tandem and tridem axles given below should be used for converting different axle load repetitions into equivalent standard axle load repetitions. Since the VDF values in AASHO Road Test for flexible and rigid pavement are not much different, for heavy duty pavements, the computed VDF values are assumed to be same for bituminous pavements with cemented and granular bases.

$$\text{Single axle with single wheel on either side} = \left( \frac{\text{axle load in kN}}{65} \right)^4 \quad \dots 4.1$$

$$\text{Single axle with dual wheels on either side} = \left( \frac{\text{axle load in kN}}{80} \right)^4 \quad \dots 4.2$$

$$\text{Tandem axle with dual wheels on either side} = \left( \frac{\text{axle load in kN}}{148} \right)^4 \quad \dots 4.3$$

$$\text{Tridem axles with dual wheels on either side} = \left( \frac{\text{axle load in kN}}{224} \right)^4 \quad \dots 4.4$$

**4.4.4** VDF should be arrived at carefully by carrying out specific axle load surveys on the existing roads. Minimum sample size for survey is given in **Table 4.1**. Axle load survey should be carried out without any bias for loaded or unloaded vehicles. On some sections, there may be significant difference in axle loading in two directions of traffic. In such situations, the VDF should be evaluated direction wise. Each direction can have different pavement thickness for divided highways depending upon the loading pattern.

**Table 4.1 Sample Size for Axle Load Survey**

Total number of Commercial Vehicles per day	Minimum Percentage of Commercial Traffic to be Surveyed
<3000	20 per cent
3000 to 6000	15 per cent
>6000	10 per cent

#### 4.4.5 Axle load spectrum

The spectrum of axle load in terms of axle weights of single, tandem, tridem and multi-axle should be determined and compiled under various classes with class intervals of 10 kN, 20 kN and 30 kN for single, tandem and tridem axles respectively.

4.4.6 Where sufficient information on axle loads is not available and the small size of the project does not warrant an axle load survey, the default values of vehicle damage factor as given in **Table 4.2** may be used.

**Table 4.2 Indicative VDF Values**

Initial Traffic Volume in Terms of Commercial Vehicles Per Day	Terrain	
	Rolling/Plain	Hilly
0-150	1.5	0.5
150-1500	3.5	1.5
More than 1500	4.5	2.5

#### 4.5 Distribution of Commercial Traffic Over the Carriageway

4.5.1 Distribution of commercial traffic in each direction and in each lane is required for determining the total equivalent standard axle load applications to be considered in the design. In the absence of adequate and conclusive data, the following distribution may be assumed until more reliable data on placement of commercial vehicles on the carriageway lanes are available:

(i) **Single-lane roads**

Traffic tends to be more channelized on single-lane roads than two-lane roads and to allow for this concentration of wheel load repetitions, the design should be based on total number of commercial vehicles in both directions.

(ii) **Two-lane single carriageway roads**

The design should be based on 50 per cent of the total number of commercial vehicles in both directions. If vehicle damage factor in one direction is higher, the traffic in the direction of higher VDF is recommended for design.

(iii) **Four-lane single carriageway roads**

The design should be based on 40 per cent of the total number of commercial vehicles in both directions.

(iv) **Dual carriageway roads**

The design of dual two-lane carriageway roads should be based on 75 per cent of the number of commercial vehicles in each direction. For dual



three-lane carriageway and dual four lane carriageway, the distribution factor will be 60 per cent and 45 per cent respectively.

**4.5.2** Where there is no significant difference between traffic in each of the two directions, the design traffic for each direction may be assumed as half of the sum of traffic in both directions. Where significant difference between the two streams exists, pavement thickness in each direction can be different and designed accordingly.

For two way two lane roads, pavement thickness should be same for both the lanes even if VDF values are different in different directions and designed for higher VDF. For divided carriageways, each direction may have different thickness of pavements if the axle load patterns are significantly different.

## 4.6 Computation of Design Traffic

**4.6.1** The design traffic in terms of the cumulative number of standard axles to be carried during the design life of the road should be computed using the following equation:

$$N = \frac{365 \times [(1 + r)^n - 1]}{r} \times A \times D \times F \quad 4.5$$

Where,

- N = Cumulative number of standard axles to be catered for in the design in terms of msa.
- A = Initial traffic in the year of completion of construction in terms of the number of Commercial Vehicles Per Day (CVPD).
- D = Lane distribution factor (as explained in para 4.5.1).
- F = Vehicle Damage Factor (VDF).
- n = Design life in years.
- r = Annual growth rate of commercial vehicles in decimal (e.g., for 5 per cent annual growth rate, r = 0.05).

The traffic in the year of completion is estimated using the following formula:

$$A = P (1 + r)^x \quad 4.6$$

Where,

- P = Number of commercial vehicles as per last count.
- x = Number of years between the last count and the year of completion of construction.

## 5 SUBGRADE

### 5.1 Requirements of CBR for Subgrade

The subgrade is the top 500 mm of the embankment immediately below the bottom of the pavement, and is made up of in-situ material, select soil, or stabilized soil that forms the foundation of a pavement. It should be well compacted to limit the scope of rutting in pavement due to additional densification during the service life of pavement. Subgrade shall be compacted to a minimum of 97 per cent of laboratory dry density achieved with heavy compaction as per IS: 2720 (Part 8) for Expressways, National Highways, State Highways, Major District Roads and other heavily trafficked roads. IRC: 36 "Recommended Practice for the Construction of Earth Embankments and Sub-grades for Road Works" should be followed for guidance during planning and execution of work. The select soil forming the subgrade should have a minimum CBR of 8 per cent for roads having traffic of 450 commercial vehicles per day or higher. The guidelines for preparation of samples, testing and acceptance criteria are given in sub-paras given below. The in-situ CBR of the sub grade soil can also be determined from the Dynamic Cone Penetrometer (60° cone) from the following relation (ASTM-D6951-09) (11).

$$\text{Log}_{10} \text{ CBR} = 2.465 - 1.12 \text{ log}_{10} N \quad 5.1$$

Where N = mm/blow

#### 5.1.1 Selection of dry density and moisture content for test specimen

**5.1.1.1** The laboratory test conditions should represent the field conditions as closely as possible. Compaction in the field is done at a minimum of 97 per cent of laboratory density at moisture content corresponding to the optimum moisture content. In actual field condition, the subgrade undergoes moisture variations depending upon local environmental factors, such as, the water table, precipitation, soil permeability, drainage conditions and the extent to which the pavement is waterproof, which affect the strength of the subgrade in terms of CBR. In high rainfall areas, lateral infiltration through unpaved shoulder, through defects in wearing surfaces or through cracks may have significant effect on the subgrade moisture condition.

As a general practice, the worst field moisture is simulated by soaking the specimens in water for four days.

#### 5.1.1.2 Number of tests, design value and tolerance limit

Where different types of soils are used in subgrade, a minimum of six to eight average CBR values (average of three tests) for each soil type along the alignment will be required for determination of design CBR. The 90<sup>th</sup> percentile of these values should be adopted as the design CBR (such that 90 per cent of the average CBR values are equal or greater than the design value) for high volume roads such as Expressways, National Highways and State Highways. For other categories of roads, design can be based on 80<sup>th</sup> percentile of laboratory CBR values. Method of computation of 90<sup>th</sup> percentile CBR is given in **Annex IV**. Pavement

thickness on new roads may be modified at intervals as dictated by the changes in soil profile but generally it will be found inexpedient to do so frequently from practical considerations.

The maximum permissible variation within the CBR values of the three specimens should be as indicated in **Table 5.1**.

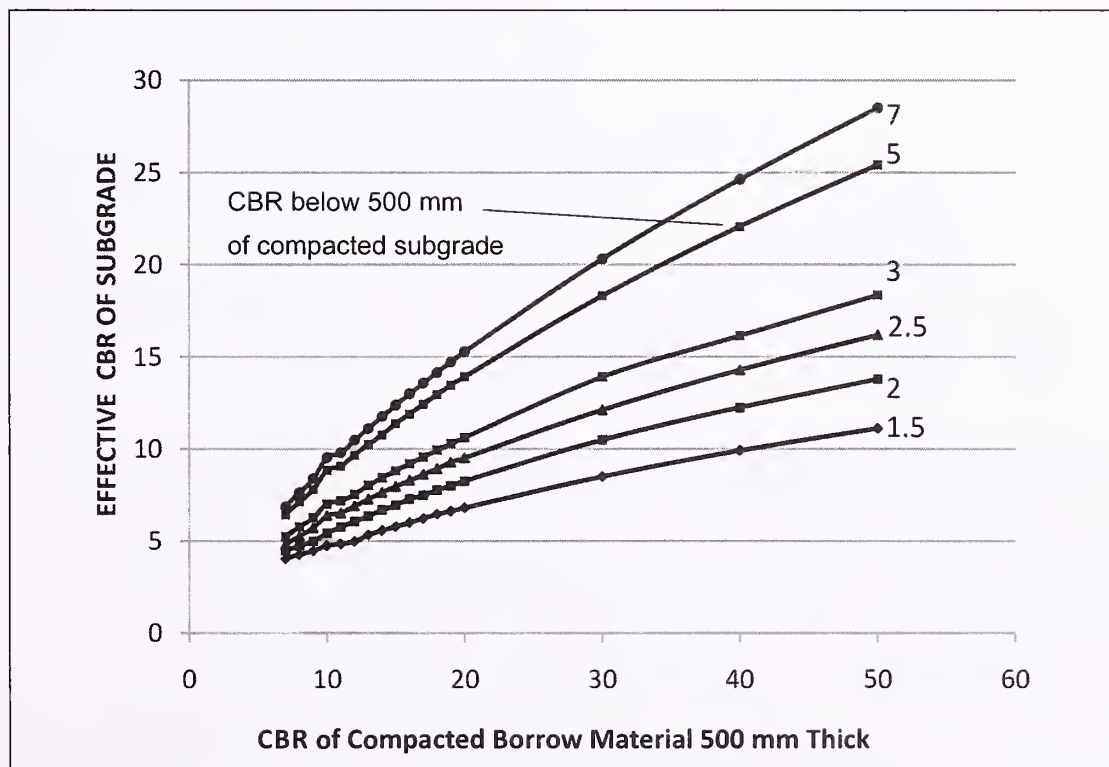
**Table 5.1 Permissible Variation in CBR Value**

CBR ( per cent)	Maximum Variation in CBR Value
5	±1
5-10	±2
11-30	±3
31 and above	±5

Where variation is more than the above, the average CBR should be the average of test results from at least six samples and not three.

**5.2 Effective CBR**

Where there is significant difference between the CBRs of the select subgrade and embankment soils, the design should be based on effective CBR. The effective CBR of the subgrade can be determined from **Fig. 5.1**. For other compacted thickness of subgrade, ref 4 may be consulted for guidance.



**Fig. 5.1 Effective CBR of Subgrade**



In case the borrow material is placed over rocky foundation, the effective CBR may be larger than the CBR of the borrow material. Use of the CBR of the borrow material may be adopted for pavement design with proper safeguards against development of pore water pressure between the foundation and the borrow material.

### 5.3 Determination of Resilient Modulus

The behaviour of the subgrade is essentially elastic under the transient traffic loading with negligible permanent deformation in a single pass. Resilient modulus is the measure of its elastic behaviour determined from recoverable deformation in the laboratory tests. The modulus is an important parameter for design and the performance of a pavement. This can be determined in the laboratory by conducting tests as per procedure specified in AASHTO T 307-99(2003) (1). Since the repetitive triaxial testing facility is not widely available and is expensive, the default resilient modulus can be estimated from generally acceptable correlations which are as follows:

The relation between resilient modulus and the effective CBR is given as:

$$\left. \begin{aligned} M_R \text{ (MPa)} &= 10 * \text{CBR} && \text{for CBR } \leq 5 \\ &= 17.6 * (\text{CBR})^{0.64} && \text{for CBR} > 5 \end{aligned} \right\} \dots 5.2$$

$M_R$  = Resilient modulus of subgrade soil.

The CBR of the subgrade should be determined as per IS: 2720 (Part 16) (36) at the most critical moisture conditions likely to occur at site. The test must always be performed on remoulded samples of soils in the laboratory. The pavement thickness should be based on 4-day soaked CBR value of the soil, remoulded at placement density and moisture content ascertained from the compaction curve. In areas with rainfall less than 1000 mm, four day soaking is too severe a condition for well protected subgrade with thick bituminous layer and the strength of the subgrade soil may be underestimated. If data is available for moisture variation in the existing in-service pavements of a region in different seasons, moulding moisture content for the CBR test can be based on field data. Wherever possible the test specimens should be prepared by static compaction. Alternatively dynamic compaction may also be used. Both procedures are described in brief in **Annex IV**.

## 6 PRINCIPLES OF PAVEMENT DESIGN

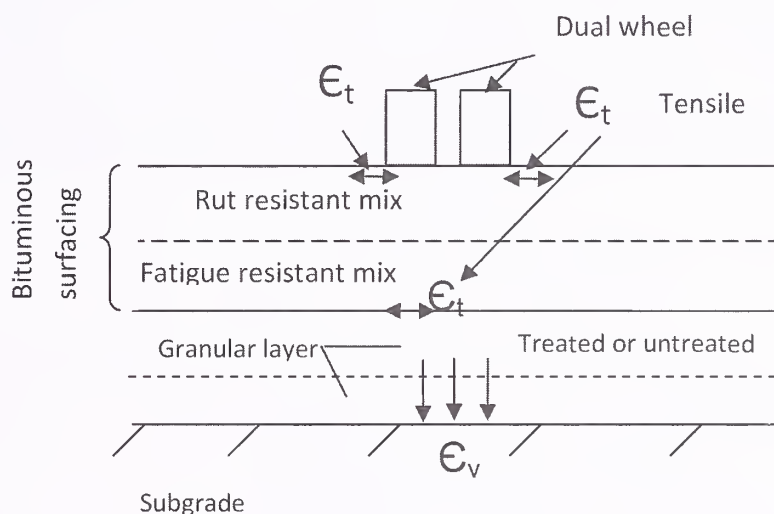
*(Users of these guidelines are advised to read this section in conjunction with Annexes I to XI for a better appreciation of the context and the requirements of pavement design)*

### 6.1 Pavement Model

A flexible pavement is modelled as an elastic multilayer structure. Stresses and strains at critical locations (**Fig. 6.1**) are computed using a linear layered elastic model. The Stress analysis software IITPAVE has been used for the computation of stresses and strains in flexible pavements. Tensile strain,  $\epsilon_t$ , at the bottom of the bituminous layer and the vertical



subgrade strain,  $\epsilon_v$ , on the top of the subgrade are conventionally considered as critical parameters for pavement design to limit cracking and rutting in the bituminous layers and non-bituminous layers respectively. The computation also indicates that tensile strain near the surface close to the edge of a wheel can be sufficiently large to initiate longitudinal surface cracking followed by transverse cracking much before the flexural cracking of the bottom layer if the mix tensile strength is not adequate at higher temperatures.



**Fig. 6.1 Different Layers of a Flexible Pavement**

## 6.2 Fatigue in Bottom Layer of Bituminous Pavement and Fatigue Life

**6.2.1** With every load repetition, the tensile strain developed at the bottom of the bituminous layer develops micro cracks, which go on widening and expanding till the load repetitions are large enough for the cracks to propagate to the surface over an area of the surface that is unacceptable from the point of view of long term serviceability of the pavement. The phenomenon is called fatigue of the bituminous layer and the number of load repetitions in terms of standard axles that cause fatigue denotes the fatigue life of the pavement. In these guidelines, cracking in 20 per cent area has been considered for traffic up to 30 msa and 10 per cent for traffic beyond that.

### 6.2.2 Fatigue model

Fatigue model has been calibrated in the R-56 (54) studies using the pavement performance data collected during the R-6 (57) and R-19 (58) studies sponsored by MORTH. Two fatigue equations were fitted, one in which the computed strains in 80 per cent of the actual data in the scatter plot were higher than the limiting strains predicted by the model (and termed as 80 per cent reliability level in these guidelines) and the other corresponding to 90 per cent reliability level. The two equations for the conventional bituminous mixes designed by Marshall method are given below:

$$N_f = 2.21 \times 10^{-04} \times [1/\epsilon_t]^{3.89} \times [1/M_R]^{0.854} \quad (80 \text{ per cent reliability}) \quad 6.1$$

$$N_f = 0.711 \times 10^{-04} \times [1/\epsilon_t]^{3.89} \times [1/M_R]^{0.854} \quad (90 \text{ per cent reliability}) \quad 6.2$$

Where,

$N_f$  = fatigue life in number of standard axles,

$\epsilon_t$  = Maximum tensile strain at the bottom of the bituminous layer, and

$M_R$  = resilient modulus of the bituminous layer.

As per the then prevailing practice, the mixes used in the pavements under study sections were generally designed for 4.5 per cent air voids and bitumen content of 4.5 per cent by weight of the mix (which in terms of volume would come to 11.5 per cent). Most literature recommend a factor 'C' to be introduced in fatigue models to take into account the effect of air voids ( $V_a$ ) and volume of bitumen ( $V_b$ ), which is given by the following relationships

$$C = 10^M, \text{ and } M = 4.84 \left( \frac{V_b}{V_a + V_b} - 0.69 \right)$$

Corresponding to the values of  $V_a$  and  $V_b$  as stated above, introduction of 'C' in Equation 6.2 leads to Equation 6.3 below.

$$N_f = 0.5161 * C * 10^{-04} \times [1/\epsilon_t]^{3.89} * [1/M_R]^{0.854} \quad 6.3$$

Many well known fatigue models also (3, 8 and 60) include the above approach to take into account the effect of volume of bitumen and air voids in the bituminous mix. Equation 6.3 would demonstrate that slight changes in volume air voids ( $V_a$ ) and volume of bitumen ( $V_b$ ) will have huge impact on the fatigue life. For example If bitumen content is increased by 0.5 per cent to 0.6 per cent above the optimum bitumen content given by Marshall test and air void is reduced to the minimum acceptable level of 3 per cent, volume of bitumen increases to the level of 13 per cent and the fatigue life would be increased by about three times. The recommendation in these guidelines is to target low air voids and higher bitumen content for the lower layer to obtain fatigue resistant mix.

Equation 6.1 is recommended for use for traffic up to 30 msa where normal bituminous mixes with VG 30 bitumen can be used. Equation 6.3 is recommended for use for traffic greater than 30 msa where richer bituminous mixes with stiffer VG 40 binder should be used. Volume of stiffer grade bitumen is possible to be increased by slightly opening the grading. The guidelines recommend that the designer should consider these aspects with a view to achieving a high fatigue life of bituminous mixes. A discussion on effect of modulus of mixes, air voids and volume of bitumen on fatigue behaviour of bituminous mixes are given in **Annex I**.

### 6.3 Rutting in Pavement

**6.3.1** Rutting is the permanent deformation in pavement usually occurring longitudinally along the wheel path. The rutting may partly be caused by deformation in the subgrade and other non-bituminous layers which would reflect to the overlying layers to take a deformed shape. The bituminous mixes also may undergo rutting due to secondary compaction and

shear deformation under heavy traffic load and higher temperature. Excessive rutting greatly reduces the serviceability of the pavement and therefore, it has to be limited to a certain reasonable value. In these guidelines the limiting rutting is recommended as 20 mm in 20 per cent of the length for design traffic up to 30 msa and 10 per cent of the length for the design traffic beyond.

### 6.3.2 *Rutting model*

Like the fatigue model, rutting model also has been calibrated in the R-56 studies using the pavement performance data collected during the R-6 (57) and R-19 (58) studies at 80 per cent and 90 per cent reliability levels. The two equations are given below:

$$N = 4.1656 \times 10^{-08} [1/\epsilon_v]^{4.5337} \quad \dots 6.4$$

$$N = 1.41 \times 10^{-8} \times [1/\epsilon_v]^{4.5337} \quad \dots 6.5$$

Where,

N = Number of cumulative standard axles, and

$\epsilon_v$  = Vertical strain in the subgrade

As can be seen, the model considers the vertical strain in subgrade as the only variable for rutting, which, is a measure of bearing capacity of the subgrade. Rutting in granular layer also is lower when the vertical subgrade elastic strains are given by Equations 6.4 and 6.5. A granular layer founded on a strong subgrade has a high resilient modulus and resists rutting when not highly stressed. Rutting in the bituminous layers also occurs due to the secondary compaction and shear deformation apart from that in the subgrade. This needs to be addressed. The recommendation in these guidelines is to provide rut resistant bituminous mixes using higher viscosity grade bitumen or modified bitumen.

## 6.4 **Top Down Cracking in Bituminous Layer**

While fatigue cracking is conventionally considered as a 'bottom-up cracking' phenomenon, 'top down cracking' has also been observed on high volume roads in the country, because of excessive tensile stresses developing at the top surface due to heavy axle loads. These guidelines recommend a high modulus rut as well as fatigue resistant mix to prevent top down cracking.

## 6.5 **Cementitious Sub-base and Base**

**6.5.1** Cementitious materials normally crack due to shrinkage and temperature changes even without pavement being loaded. Slow setting cementitious materials having low cement content develop fine cracks and have to be preferred to high cement content mixes producing wider cracks. While making a judgment on the strength values for design, the reduction in strength due to the cracked condition of these layers need to be fully recognized. The Elastic Modulus (E) recommended for design is much lower than their respective laboratory value



obtained from unconfined compression test. The extent of reductions proposed has been generally in agreement with practices followed in the national standards of other countries like Australia, South Africa, MEPDG of the USA etc. There are limited data in the country on the field performance of such type of construction to understand and model their performance in the field. Therefore, the new pavements constructed with these materials need to be closely monitored by Falling Weight Deflectometer (FWD) for the evaluation of material properties for future guidance. These guidelines strongly recommend construction with cementitious materials in the interest of saving the environment and using the local and marginal materials after stabilization. Validated results of cemented pavement layers from other countries and use of a sound analytical tool are likely to give good performing pavements at an affordable cost consistent with environmental requirement, and the availability of limited data of field performance in India need not be considered a handicap. Locations where the cemented layers were used in India are given in **Annex XI** and some of them were evaluated by FWD also.

### 6.5.2 *Fatigue cracking in cementitious layers*

In these guidelines, the treatment of fatigue cracking of cement treated layers is recommended at two levels. Thickness of the cemented layer is firstly evaluated from fatigue consideration in terms of cumulative standard axles. At the second level, the cumulative fatigue damage due to individual axles is calculated based on a model which uses 'stress ratio' (the ratio of actual stresses developed due to a class of wheel load and the flexural strength of the material) as the parameter. The computation of stresses due to the individual wheel load is done by the IITPAVE program. An excel sheet can be used to calculate the cumulative fatigue damage of each class of wheel loads and sum up the cumulative damage for the entire axle load spectrum. The design requirement is that the cumulative damage of all wheel loads should be less than 1 during the design life of a pavement. If it is greater than 1, the section has to be changed and iteration done again. The first model is taken from the Australian experience, while the second one is suggested in MEPDG. The second level analysis is necessary only when very heavy traffic is operating on the highways. The two fatigue equations are given below:

#### A. Fatigue Life in Terms of Standard Axles

$$N = RF \left[ \frac{(11300/E^{.0804} + 191)}{\epsilon_t} \right]^{12} \quad \dots 6.6$$

Where,

- RF = Reliability factor for cementitious materials for failure against fatigue.  
= 1 for Expressways, National Highways and other heavy volume roads.  
= 2 for others carrying less than 1500 trucks per day.
- N = Fatigue life of the cementitious material.
- E = Elastic modulus of cementitious material.
- $\epsilon_t$  = tensile strain in the cementitious layer, microstrain.

## B. Fatigue Equation for Cumulative Damage Analysis

In fatigue analysis of cementitious bases, the spectrum of axle loads has to be compiled under various axle load classes. Axle weights of tandem and tridem axle may be taken as equivalent to two and three single axles respectively because axles located at distances more than 1.30 m apart are not considered as causing any significant overlapping of stresses. The fatigue life is given by the following equation:

$$\text{Log } N_{fi} = \frac{0.972 - (\sigma_t / M_{Rup})}{0.0825} \quad \dots 6.7$$

Where,

$N_{fi}$  = Fatigue life in terms of cumulative number of axle load of class  $i$

$\sigma_t$  = tensile stress under cementitious base layer.

$M_{Rup}$  = 28 day flexural strength of the cementitious base.

The fatigue criterion is considered satisfied if  $\Sigma(N_i/N_{fi})$  is less than 1, where  $N_i$  is the actual number of axles of axle load of *class i*.

## 7 PAVEMENT COMPOSITION

### 7.1 General

A flexible pavement covered in these guidelines consists of different layers as shown in Fig. 7.1.

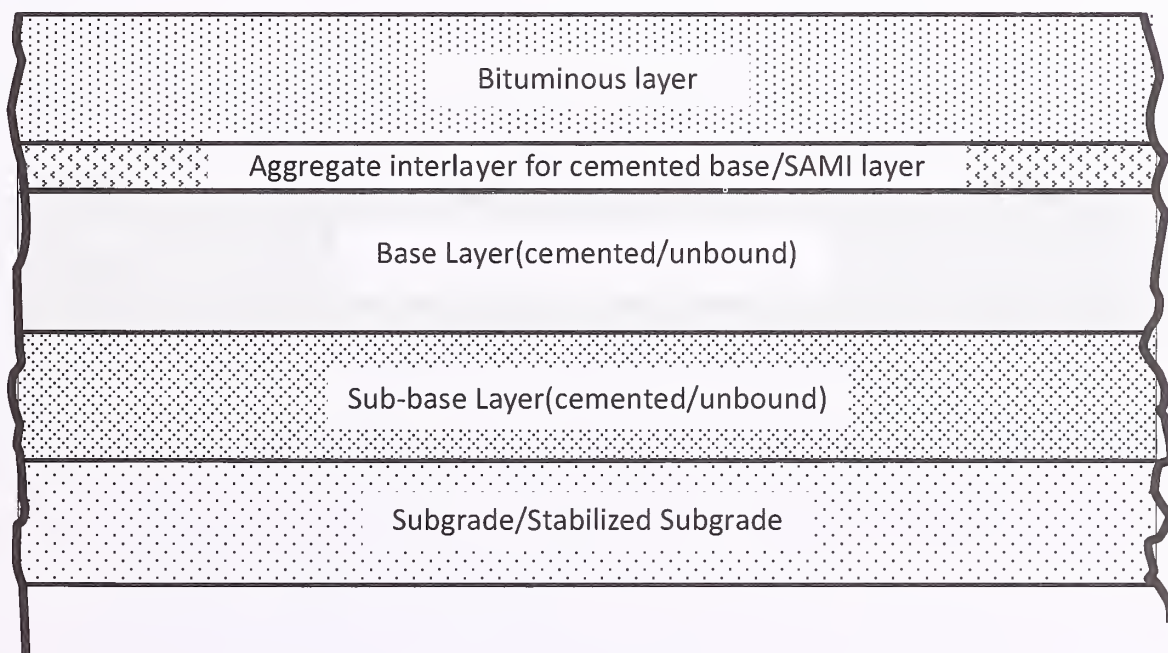


Fig. 7.1 Different Layers of Bituminous Pavement

The sub-base and the base layer can be unbound (e.g. granular) or chemical stabilized with stabilizers such as cement, lime, flyash and other cementitious stabilizers. In case of pavements with cementitious base, a crack relief layer provided between the bituminous layer and the cementitious base delays considerably the reflection crack in the bituminous course. This may consist of crushed aggregates of thickness 100 mm of WMM conforming to IRC/MORTH Specifications or Stress Absorbing Membrane Interlayer (SAMI) of elastomeric modified binder at the rate of about 2 litre/m<sup>2</sup> covered with light application of 10 mm aggregates to prevent picking up of the binder by construction traffic(AUSTROADS).

The unbound base layer may consist of granular layer such as Wet Mix Macadam (MORTH Specification for Road & Bridge Works) and water bound macadam. The base layer may consist of granular materials treated with bitumen emulsion of SS2 grade or foamed bitumen. Fresh aggregates or aggregates obtained from reclaimed asphalt pavements when treated with foamed bitumen or bitumen emulsion should have the required indirect tensile strength to be considered as a base layer.

The sub-base layer serves three functions, viz., to protect the subgrade from overstressing, to provide a platform for the construction traffic and to serve as drainage and filter layer. The design of sub-base, whether bound or unbound, should meet these functional requirements.

## **7.2 Sub-base Layer**

### **7.2.1 Unbound sub-base layer**

**7.2.1.1** Sub-base materials may consist of natural sand, moorum, gravel, laterite, kankar, brick metal, crushed stone, crushed slag and reclaimed crushed concrete/reclaimed asphalt pavement or combinations thereof meeting the prescribed grading and physical requirements. When the sub-base material consists of combination of materials, mixing should be done mechanically either using a suitable mixer or adopting mix-in-place method. The sub-base should have sufficient strength and thickness to serve the construction traffic.

**7.2.1.2** Specifications of granular sub-base (GSB) materials conforming to MORTH Specifications for Road and Bridge Works are recommended for use. These specifications suggest close and coarse graded granular sub-base materials and specify that the materials passing 425 micron sieve when tested in accordance with IS:2720 (Part 5) should have liquid limit and plasticity index of not more than 25 and 6 respectively. These specifications and the specified grain size distribution of the sub-base material should be strictly enforced in order to meet strength, filter and drainage requirements of the granular sub-base layer. When coarse graded sub-base is used as a drainage layer, Los Angeles abrasion value should be less than 40 so that there is no excessive crushing during the rolling and the required permeability is retained and fines passing 0.075 mm should be less than 2 per cent.

**7.2.1.3** The sub-base should be composed of two layers, the lower layer forms the separation/filter layer to prevent intrusion of subgrade soil into the pavement and the upper GSB forms the drainage layer to drain away any water that may enter through surface cracks.



The drainage layer should be tested for permeability and gradation may be altered to ensure the required permeability. Filter and drainage layers can be designed as per IRC: SP: 42-1994 (33) and IRC:SP:50-1999(34).

#### 7.2.1.4 *Strength parameter*

The relevant design parameter for granular sub-base is resilient modulus ( $M_R$ ), which is given by the following equation:

$$M_{R_{gsb}} = 0.2h^{0.45} * M_{R_{subgrade}} \quad \dots 7.1$$

Where h = thickness of sub-base layer in mm

$M_R$  value of the sub-base is dependent upon the  $M_R$  value of the subgrade since weaker subgrade does not permit higher modulus of the upper layer because of deformation under loads.

#### 7.2.2 *Bound sub-base layer*

7.2.2.1 The material for bound sub-base may consist of soil, aggregate or soil aggregate mixture modified with chemical stabilizers such as cement, lime-flyash, commercially available stabilizers<sup>1</sup> etc. The drainage layer of the sub-base may consist of coarse graded aggregates bound with about 2 per cent cement while retaining the permeability. In case the soil modified with cementitious material is used as a sub-base and granular material is not easily available, commercially available geo-composites possessing the necessary permeability can be used to serve both as a drainage and filter/separation layer. Drainage and separation layers are essential when water is likely to enter into pavements from the shoulder, median or through the cracks in surface layer.

#### 7.2.2.2 *Strength Parameter*

The relevant design parameter for bound sub-bases is the Elastic Modulus E, which can be determined from the unconfined compressive strength of the material. In case of cementitious granular sub-base having a 7-day UCS of 1.5 to 3 MPa, the laboratory based E value (AUSTROADS) is given by the following equation:

$$E_{cgsb} = 1000 * UCS \quad \dots 7.2$$

Where UCS = 28 day strength of the cementitious granular material

Equation 7.2 gives a value in the range of 2000 to 4000 MPa. Since the sub-base acts as a platform for the heavy construction traffic, low strength cemented sub-base is expected to crack during the construction and a design value of 600 MPa is recommended for the stress analysis. Poisson's ratio may be taken as 0.25.

If the stabilized soil sub-bases have 7-day UCS values in the range 0.75 to 1.5 MPa, the recommended E value for design is 400 MPa with Poisson's ratio of 0.25.

1 Where commercially available stabilizers are used, the stabilized material should meet additional requirements of leachability and concentration of heavy metals apart from the usual requirements of strength and durability.



### 7.3 Base Layer

#### 7.3.1 Unbound base layer

The base layer may consist of wet mix macadam, water bound macadam, crusher run macadam, reclaimed concrete etc. Relevant specifications of IRC/MORTH are to be adopted for the construction.

When both sub-base and the base layers are made up of unbound granular layers, the composite resilient modulus of the granular sub-base and the base is given as:

$$M_{R\_granular} = 0.2 * h^{0.45} M_{R\_subgrade} \quad \dots 7.3$$

Where  $h$  = thickness of granular sub-base and base, mm

Poisson's ratio of granular bases and sub-bases is recommended as 0.35.

#### 7.3.2 Cementitious bases

7.3.2.1 Cemented base layers may consist of aggregates or soils or both stabilized with chemical stabilizers such as cement, lime, lime-flyash or other stabilizers which are required to give a minimum strength of 4.5 to 7 MPa in 7/28 days. While the conventional cement should attain the above strength in seven days(IRC:SP-89-2010(30)), lime or lime-flyash stabilized granular materials and soils should meet the above strength requirement in 28 days since strength gain in such materials is a slow process. Though the initial modulus of the cementitious bases may be in the range 10000 to 15000 MPa, the long term modulus of the cemented layer may be taken as fifty per cent of the initial modulus due to shrinkage cracks and construction traffic (65, 66). Australian guidelines recommend use of Equation 7.2 for the cemented layer. Curing of cemented bases after construction is very important for achieving the required strength as described in IRC:SP-89 and curing should start immediately by spraying bitumen emulsion or periodical mist spray of water without flooding or other methods.

##### 7.3.2.2 Strength parameter

Flexural strength is required for carrying out the fatigue analysis as per fatigue equation. MEPDG suggests that the modulus of rupture for chemically stabilized bases can be taken as 20 per cent of the 28 day unconfined compressive strength. The same is recommended in these guidelines. The following default values of modulus of rupture are recommended for cementitious bases (MEPDG).

Cementitious stabilized aggregates	–	1.40 MPa
Lime—flyash-soil	–	1.05 MPa
Soil cement	–	0.70 MPa

Poisson's ration of the cemented layers may be taken as 0.25.

### 7.3.2.3 Durability criteria

The minimum cementitious material in the cementitious base layer should be such that in a wetting and drying test (BIS: 4332 (Part IV) - 1968) (17), the loss of weight of the stabilized material does not exceed 14 per cent after 12 cycles of wetting and drying. In cold and snow bound regions like Arunachal Pradesh, Jammu & Kashmir, Ladakh, Himachal Pradesh etc., durability should be determined by freezing and thawing test and the loss of weight should be less than 14 per cent after 12 cycles (BIS: 4332 (Part IV) – 1968) (17). The cementitious layer meeting the strength requirements of IRC:SP:89-2010 is found to meet the criteria of durability requirement (14).

### 7.3.2.4 Strength gain with time

The cementitious materials keep on gaining strength over a long time period and a 28 day strength gives a conservative design. It should be recognized that the cemented materials may possibly degrade also with time depending upon the loads, temperature and moisture conditions, freeze-thaw cycles and quantity of chemical stabilizers.

### 7.3.2.5 Crack relief layer

A SAMI layer using elastomeric modified bitumen provided over the cementitious layer delays the cracks propagating into the bituminous layer. A crack relief layer of wet mix macadam of thickness 100 mm sandwiched between the bituminous layer and treated layer is much more effective in arresting the propagation of cracks from the Cementitious base to the bituminous layer (14, 22, 65 and 66). The aggregate layer becomes stiffer under heavier loads because of high confining pressure. If there is shoving and deformation in the unbound layer caused by the construction traffic, the granular layer may be treated with 1 to 2 per cent bitumen emulsion of grade MS to avoid reshaping.

### 7.3.2.6 Modulus of crack relief layer:

The resilient modulus of a good quality granular layer provided between the cementitious and bituminous layers is dependent upon the confinement pressure under wheel load (3, 14, 26, 65 and 66). The modulus may vary from 250 to 1000 MPa and a typical value of 450 MPa (14, 65 and 66) may be used for the sandwiched aggregate layer for the analysis of pavements. Strong support from the cementitious base, results in higher modulus than what is given by Equation 7.3. Poisson's ratio of the aggregate relief layer may be taken as 0.35. A brief description on strength and resilient modulus of cementitious materials is given in **Annex VIII**.

### 7.3.3 Bitumen emulsion/foamed bitumen treated aggregates/reclaimed asphalt base.

If the base is made up of fresh aggregates or milled material from reclaimed asphalt pavements treated with foamed bitumen or bitumen emulsion, the value of resilient modulus of the material may be taken as 600 MPa while the laboratory values may range from 600 to 1200 MPa (50, 59). The above mentioned resilient modulus value can be ensured if the Indirect Tensile Strength (ASTM: D7369-09) (12) of the 100 mm diameter Marshall specimen of the Emulsion/



Foamed Bitumen treated material has a minimum value of 100 kPa in wet condition and 225 kPa in dry condition under a rate of loading of 50 mm/minute (59) at 25°C. Poisson's ratio is recommended as 0.35. Mix design and test methods are given in **Annex IX**.

## 7.4 Bituminous Layers

**7.4.1** The recommended resilient modulus values of the bituminous materials with different binders are given in **Table 7.1**. These are based on extensive laboratory testing modern testing equipments following ASTM Test procedures. The tests carried out were "Indirect Tensile Tests" (ASTM: D7369-09) (12) and "Standard Test Method for Determining Fatigue Failure of Compacted Asphalt Concrete Subjected to Repeated Flexural Bending" (ASTM: D7460-10) (13), a 'Four Point Bending Test' at 10 Hz frequency in constant strain mode. A loading pulse of 0.1 second followed by a rest period of 0.9 second were adopted for Indirect Tensile Test. It can be seen that modulus of mixes with modified binders do not necessarily give a higher resilient modulus at 35°C despite their apparent advantages in terms of higher viscosity at higher temperatures, higher softening point and lower penetration. Some modified binders tested give almost the same  $M_R$  as that with VG 30 bitumen. These findings are in agreement with those given in some other literature as well, e.g., Monismith et al (20), AUSTRROADS and others. The guidelines, therefore recommend that the modulus values of mixes with modified binder should be determined from Indirect Tensile Strength or four point bending tests and used in design because the modulus values of these will vary greatly depending upon the base bitumen, modifiers and their dosage. Notwithstanding lower modulus values, the modified mixes are known to give improved fatigue lives.

**7.4.2** Higher viscosity of bituminous binders, which can be achieved either by using higher viscosity grade bitumen or modified bitumen will improve both fatigue and rutting behaviour of mixes as compared to mixes with normal bitumen (20, 38, 42 and 69). Fatigue life can be further improved by reducing the air voids and increasing the volume of binder (both modified and unmodified). Low air voids and higher bitumen content may, however, induce bleeding and rutting, the chances of which are minimized if higher viscosity binder is used in the mix. These guidelines, therefore, recommend that these factors should be taken into account while designing bituminous mixes.

The Poisson's ratio of bituminous layer depend upon the pavement temperature and a value of 0.35 is recommended for temperature up to 35°C and value of 0.50 for higher temperatures. Stress computation is not very sensitive to minor changes in Poisson's ratio. Fatigue equation at any pavement temperature from 20°C to 40°C can be evaluated by substituting the appropriate value of the resilient modulus of the bituminous mix, air void and volume of bitumen. Catalogue of designs has been worked out for a temperature of 35°C. It is noted that the bituminous mixes harden with time and modulus may increase to higher values in upper layers due to ageing than what is given in the **Table 7.1**. Deterioration also occurs due to heavily loaded vehicles. Hence field performance is to be periodically recorded for future guidance. **Annex VII** gives various considerations for the selection of binders and mixes in the light of Indian and international experience.

**Table 7.1 Resilient Modulus of Bituminous Mixes, MPa**

Mix type	Temperature °C				
	20	25	30	35	40
BC and DBM for VG10 bitumen	2300	2000	1450	1000	800
BC and DBM for VG30 bitumen	3500	3000	2500	1700	1250
BC and DBM for VG40 bitumen	6000	5000	4000	3000	2000
BC and DBM for Modified Bitumen (IRC: SP: 53-2010)	5700	3800	2400	1650	1300
BM with VG 10 bitumen	500 MPa at 35°C				
BM with VG 30 bitumen	700 MPa at 35°C				
WMM/RAP treated with 3 per cent bitumen emulsion/ foamed bitumen (2 per cent residual bitumen and 1 per cent cementitious material).	600 MPa at 35°C (laboratory values vary from 600 to 1200 MPa for water saturated samples).				

## 8 PERPETUAL PAVEMENT

The pavement having a life of 50 years or longer is termed as a perpetual pavement. If the tensile strain caused by the traffic in the bituminous layer is less than 70 micro strains, the endurance limit of the material, the bituminous layer never cracks (Asphalt Institute, MS-4, 7<sup>th</sup> edition 2007). Similarly if vertical subgrade strain is less than 200 micro strains, there will be little rutting in subgrade. Design of such a pavement is illustrated in the guidelines. Different layers are so designed and constructed that only the surface layer is the sacrificial layer which is to be scrapped and replaced with a new layer from time to time. There is now enough evidence worldwide that deep strength bituminous pavements suffer damage only at the top and nowhere else.

## 9 PAVEMENT DESIGN PROCEDURE

### 9.1 Using IITPAVE

Any combination of traffic and pavement layer composition can be tried using IITPAVE. The designer will have full freedom in the choice of pavement materials and layer thickness. The traffic volume, number of layers, the layer thickness of individual layers and the layer properties are the user specified inputs in the Program, which gives strains at critical locations as outputs. The adequacy of design is checked by the Program by comparing these strains with the allowable strains as predicted by the fatigue and rutting models. A satisfactory pavement design is achieved through iterative process by varying layer thicknesses or, if necessary, by



changing the pavement layer materials. (See Section 13 for outline of procedures for using IITPAVE and **Annex II** for worked-out examples)

## 9.2 Using Design Catalogues

These Guidelines provide a Design catalogue giving pavement compositions for various combinations of traffic, layer configuration and assumed material properties. If the designer chooses to use any of these combinations and is satisfied that the layer properties assumed in the design catalogue can be achieved in the field, the design can be straightway adopted from the relevant design charts given in the catalogue. (See Section 10 for details)

## 9.3 Material Properties

Regardless of the design procedure, it is essential that the material properties are adopted only after conducting relevant tests on the materials. Where all test facilities are not available, at least those tests must be carried out, which can validate the assumed design properties. In **Table X-2** the type of tests required as well as the range of values for material properties are given based on typical testing and experience in other countries. The values as suggested may be adopted for pavement design as default but not without validation by subjecting the materials to such tests which can be easily carried out in any laboratory (e.g. Unconfined Compressive Strength) to validate the assumed design values.

# 10 PAVEMENT DESIGN CATALOGUES

Five different combinations of traffic and material properties have been considered for which pavement composition has been suggested in the form of design charts presented in Plates 1 to 24. Each combination has been supported with illustration to compare the proposed design thickness in the design catalogue with that given by IITPAVE (Clauses 10.1 to 10.5). The five combinations are as under:

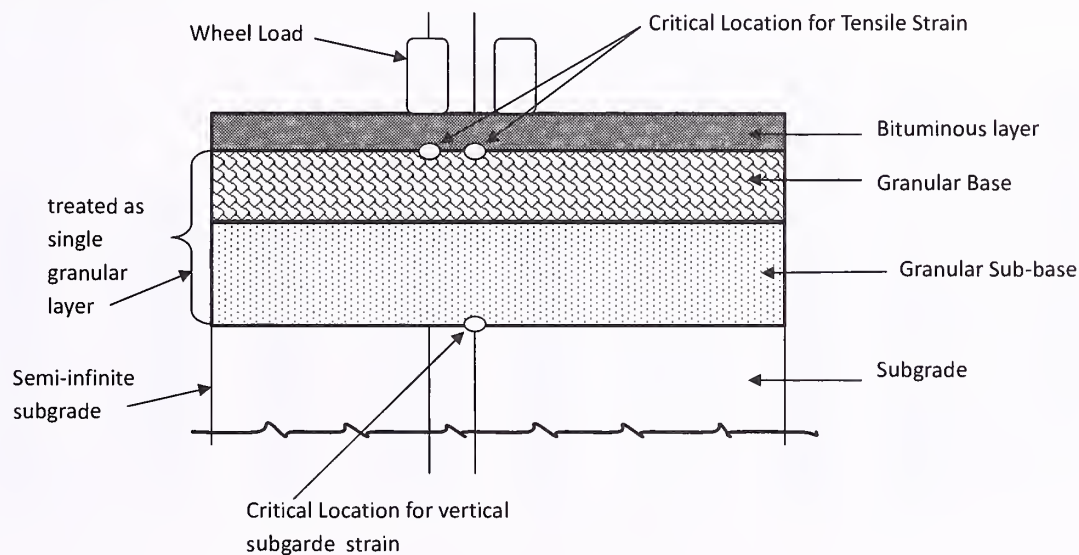
- (1) Granular Base and Granular Subbase. (Cl 10.1) (Plate 1 to 8)
- (2) Cementitious Base and Cementitious Subbase with aggregate interlayer for crack relief. Upper 100 mm of the cementitious subbase is the drainage layer. (Cl 10.2) (Plate 9 to 12)
- (3) Cementitious base and subbase with SAMI at the interface of base and the bituminous layer. (Cl 10.3) (Plate 13 to 16)
- (4) Foamed bitumen/bitumen emulsion treated RAP or fresh aggregates over 250 mm Cementitious subbase (Cl 10.4) (Plate 17 to 20)
- (5) Cementitious base and granular subbase with crack relief layer of aggregate layer above the cementitious base. (Cl 10.5) (Plate 21 to 24)

Note:

- These charts are to be used for traffic of 2 msa and above. For traffic below 2 msa IRC SP 72-2007 should be referred to. City roads should be designed for minimum 2 msa traffic.
- Thickness design for traffic between 2 and 30 msa is exactly as per IRC 37-2001.
- In all cases of cementitious sub-bases (i.e. cases 2,3 and 4 above) the top 100 mm thickness of sub-base is to be porous and act as drainage layer

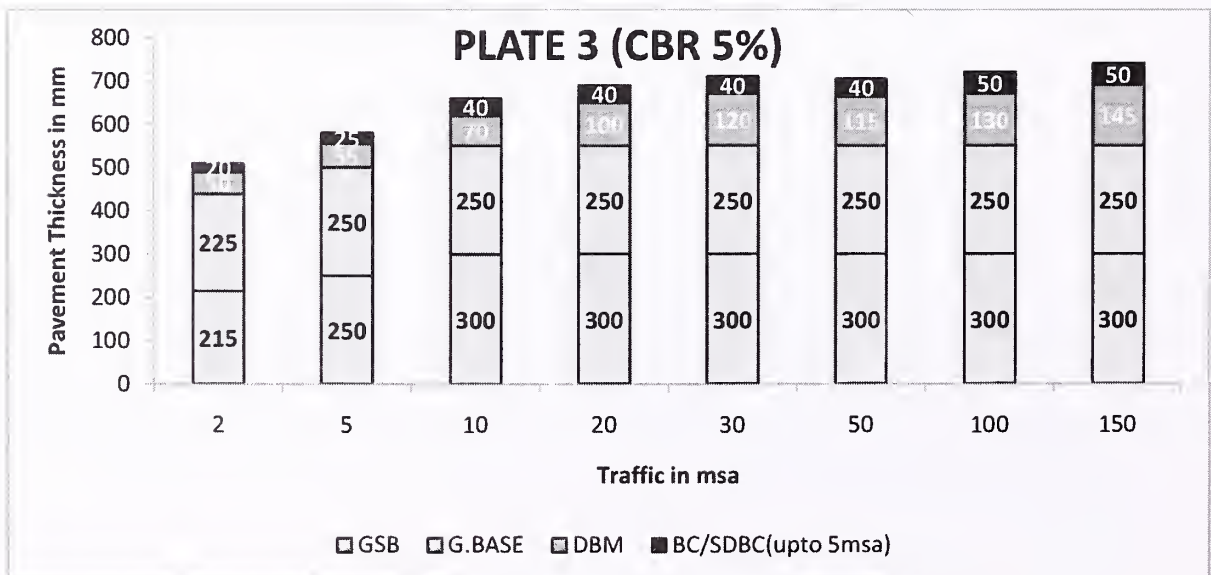
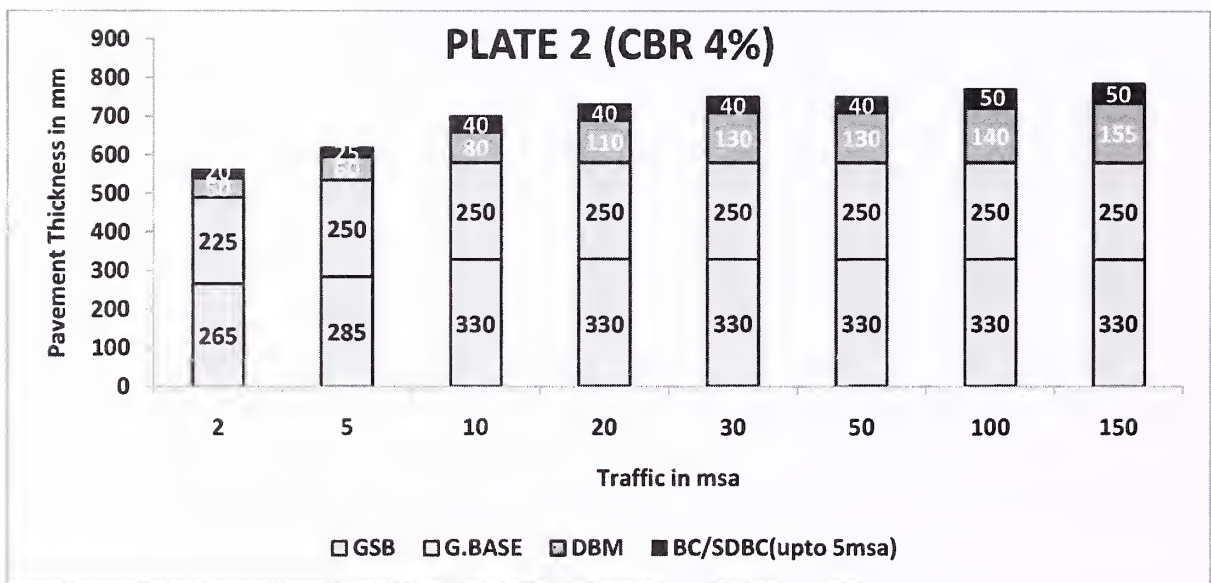
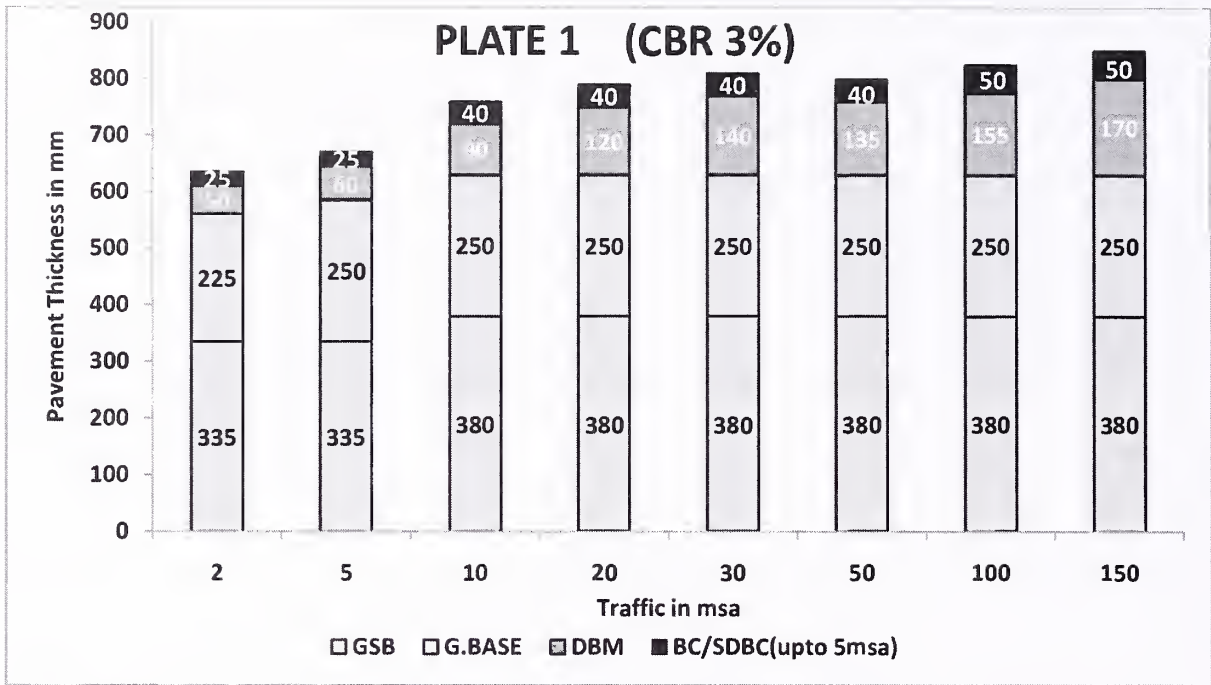
Where designer chooses to use his own combinations instead of design catalogues, this has been discussed with illustration in Clause 10.6

### 10.1 Granular Base and Granular Sub-base

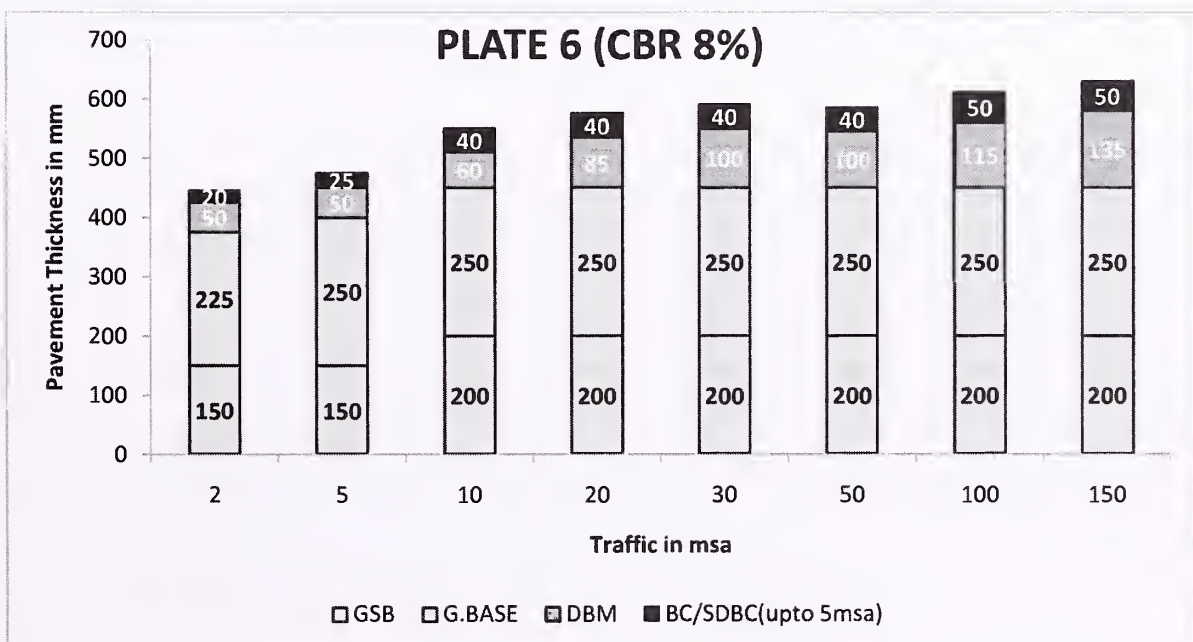
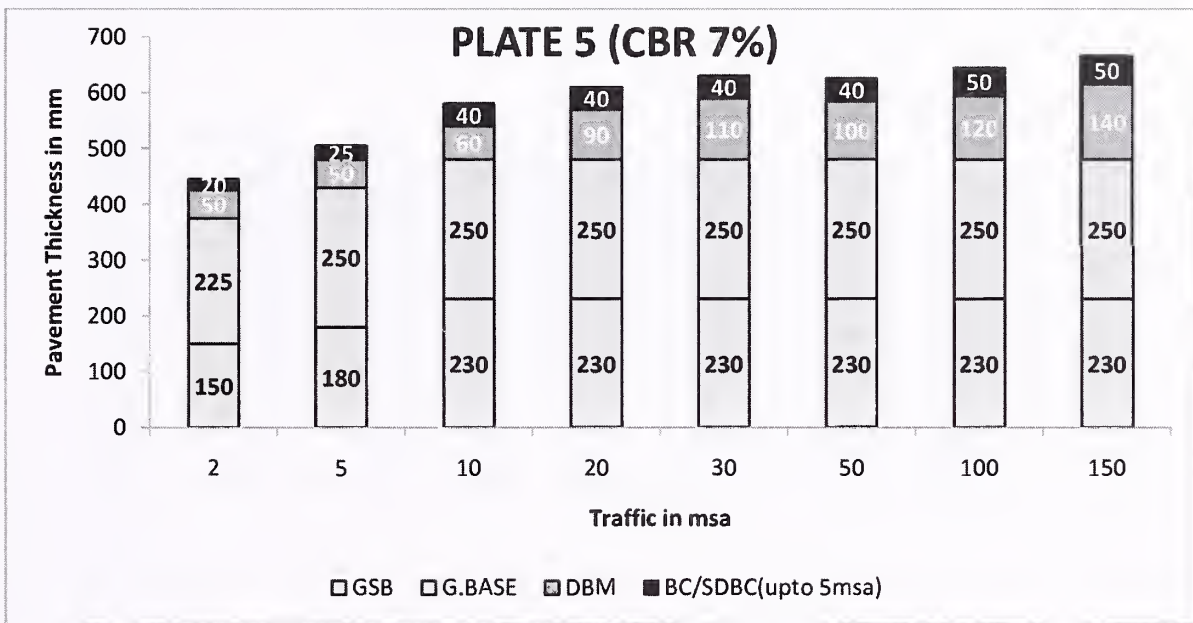
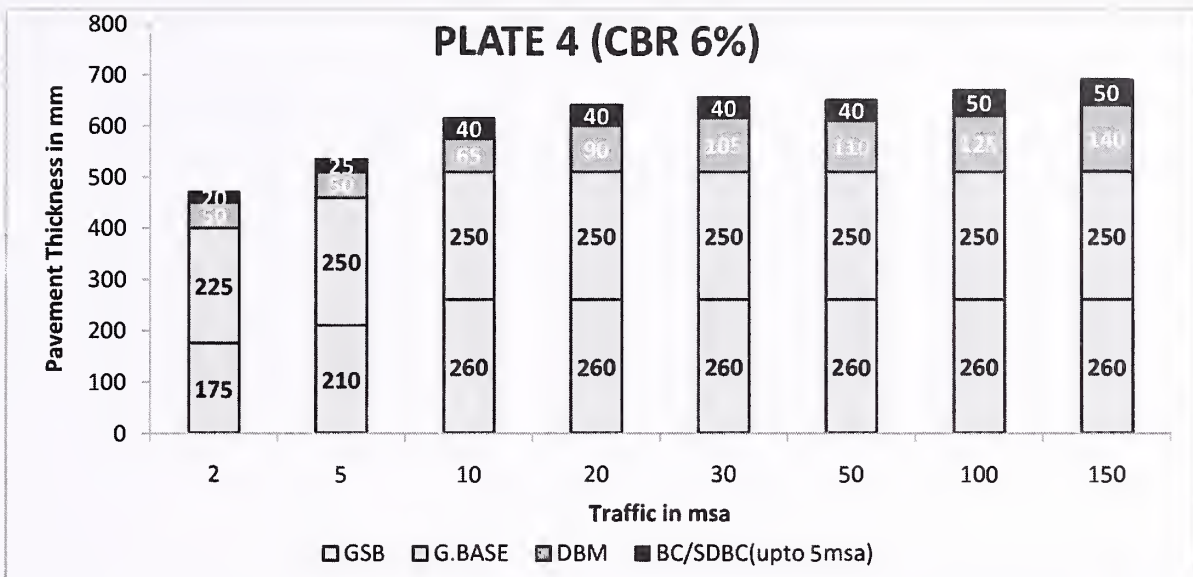


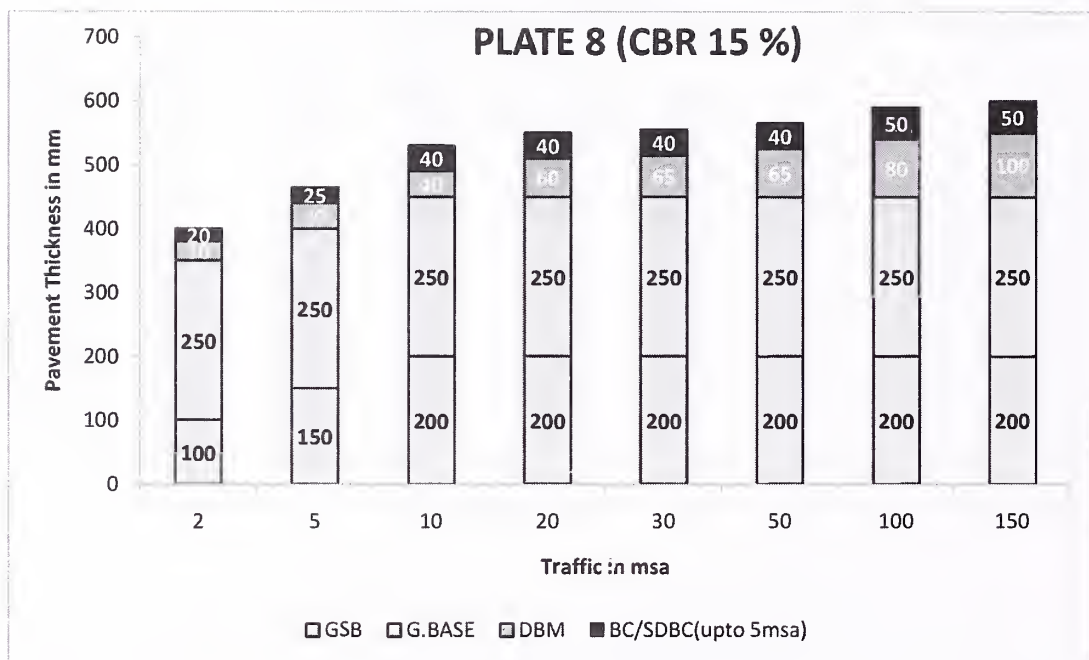
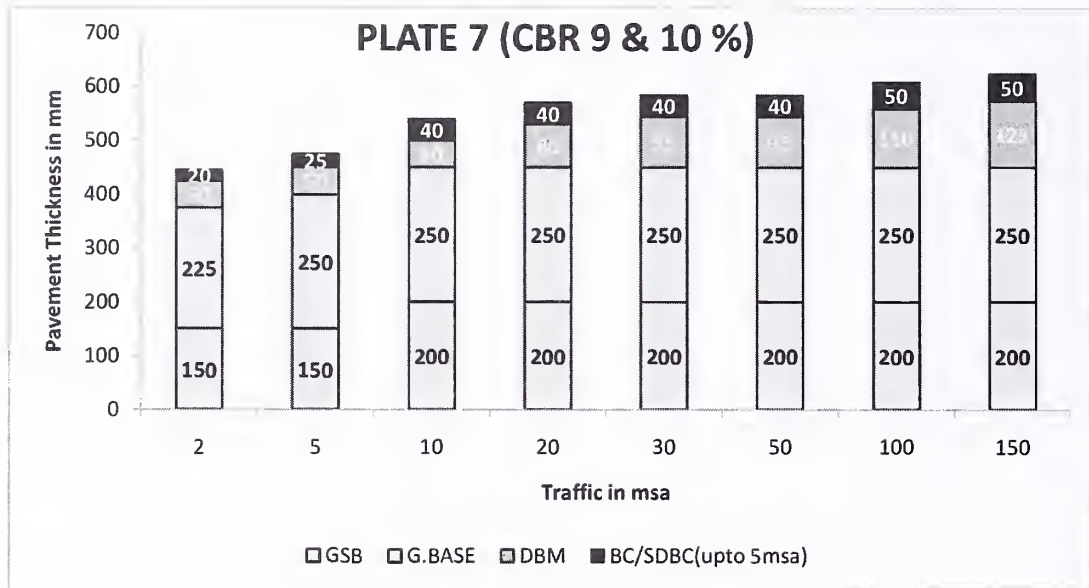
**Fig. 10.1 Bituminous Surfacing with Granular Base and Granular Sub-base.**

**Fig. 10.1** shows the cross section of a bituminous pavement with granular base and subbase. It is considered as a three layer elastic structure consisting of bituminous surfacing, granular base and subbase and the subgrade. The granular layers are treated as a single layer. Strain and stresses are required only for three layer elastic system. The critical strains locations are shown in the figure. For traffic  $> 30$  msa, VG 40 bitumen is recommended for BC as well as DBM for plains in India. Thickness of DBM for 50 msa is lower than that for 30 msa for a few cases due to stiffer bitumen. Lower DBM is compacted to an air void of 3 per cent after rolling with volume of bitumen close to 13 per cent (Bitumen content may be 0.5 per cent to 0.6 per cent higher than the optimum). Thickness combinations up to 30 msa are the same as those adopted in IRC: 37-2001. GSB consists of a separation/filter (F) in the bottom and a drainage layer (D) having the gradation 4 of **Table V-1** in **Annex V**. Coarse graded GSB of MORTH with fines less than 2 per cent may also be used.









**Illustration**

**Traffic: 150 msa**

$$\text{Subgrade CBR} = 10\%, E_{\text{subgrade}} = 17.6 \times \text{CBR}^{0.64} = 75 \text{ MPa}$$

$$M_{R\_granular} = 0.2 \times E_{\text{subgrade}} \times h^{0.45}, h = \text{thickness of granular layer (GSB + WMM)}$$

$$M_{R\_granular} = 0.2 \times 75 \times 450^{0.45} = 234 \text{ MPa}. M_{R\_bituminous \text{ layer}} = 3000 \text{ MPa}$$

For the given composition of Pavement thicknesses, 90% Reliability is adopted i.e., Eq. 6.3 and Eq. 6.5 are used (Equations 6.1 and 6.4 with 80% reliability are used for design traffic up to 30 msa).

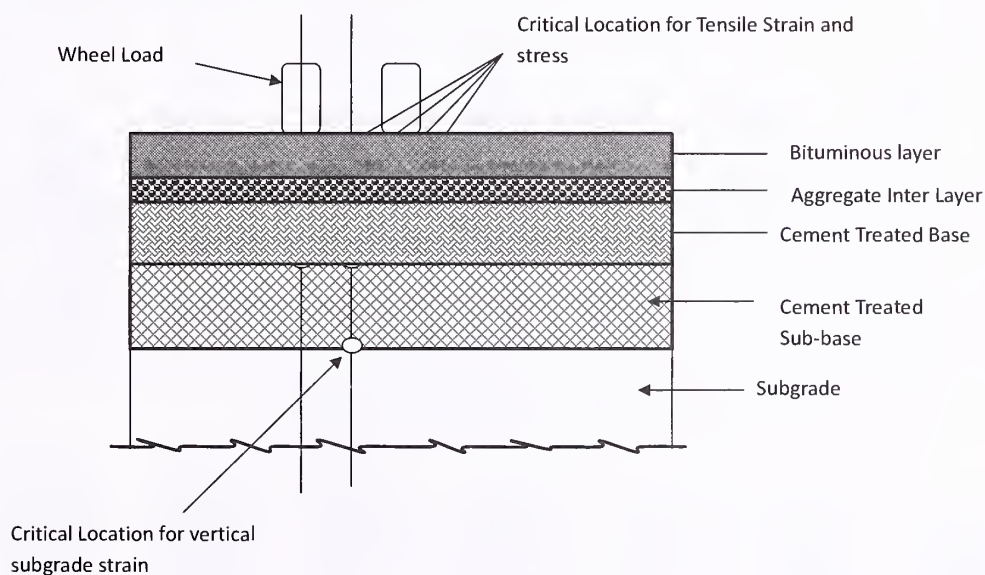
- (i) Allowable Horizontal Tensile Strain in Bituminous Layer is  $153 \times 10^{-6}$  for VG 40 mixes (Allowable value is  $178 \times 10^{-6}$  from Eq. 6.1 for a mix with VG 30 used in IRC: 37-2001).
- (ii) Allowable Vertical Compressive Strain on Subgrade is  $291 \times 10^{-6}$  (Allowable value is  $370 \times 10^{-6}$  from Eq. 6.4 used in IRC: 37-2001).

From PLATE 7, BC = 50 mm, DBM = 125 mm, WMM = 250 mm, GSB-200 mm. The computed strains From IITPAVE Software are

- (i) Horizontal Tensile Strain in Bituminous Layer is  $149 \times 10^{-6} < .153 \times 10^{-6}$
- (ii) Vertical Compressive Strain on Subgrade is  $244 \times 10^{-6} < 291 \times 10^{-6}$

Hence the Pavement Composition is Safe.

## 10.2 Bituminous Pavements with Cemented Base and Cemented Subbase with Crack Relief Interlayer of Aggregate

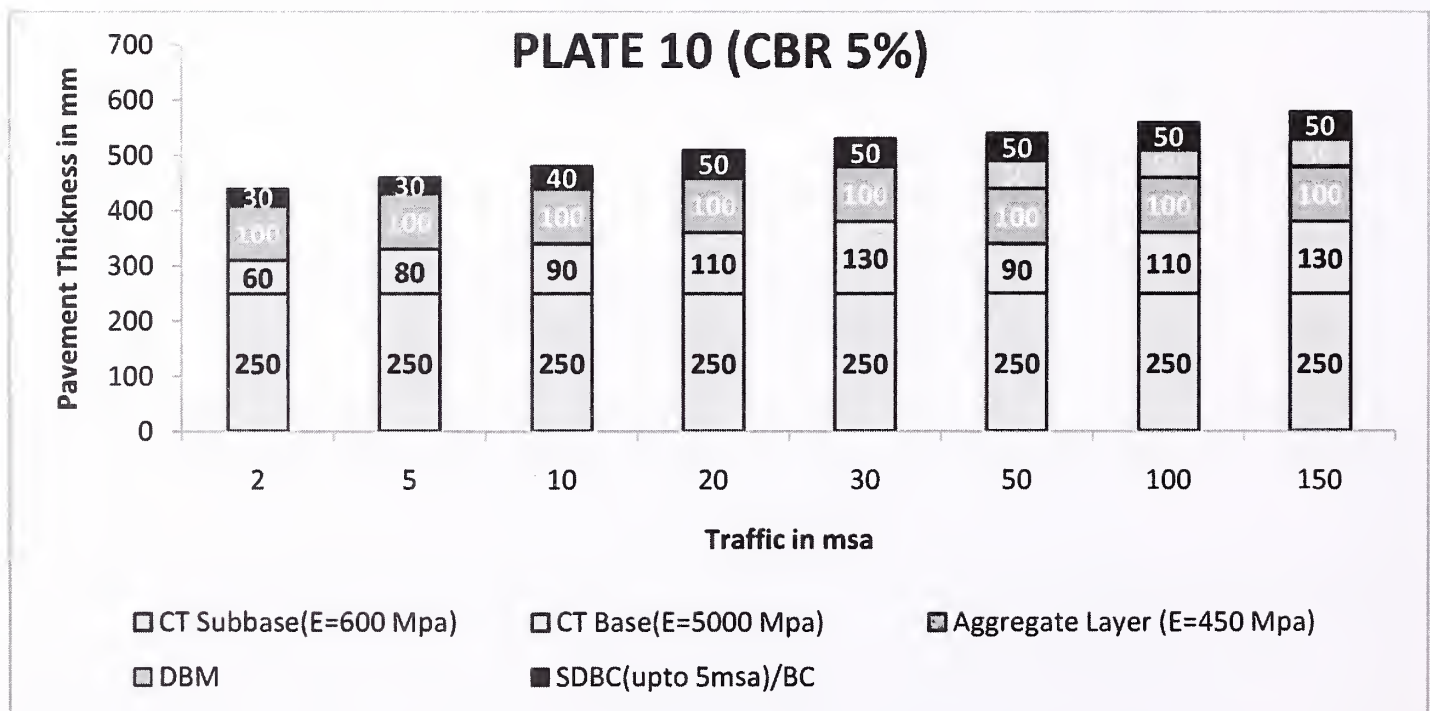
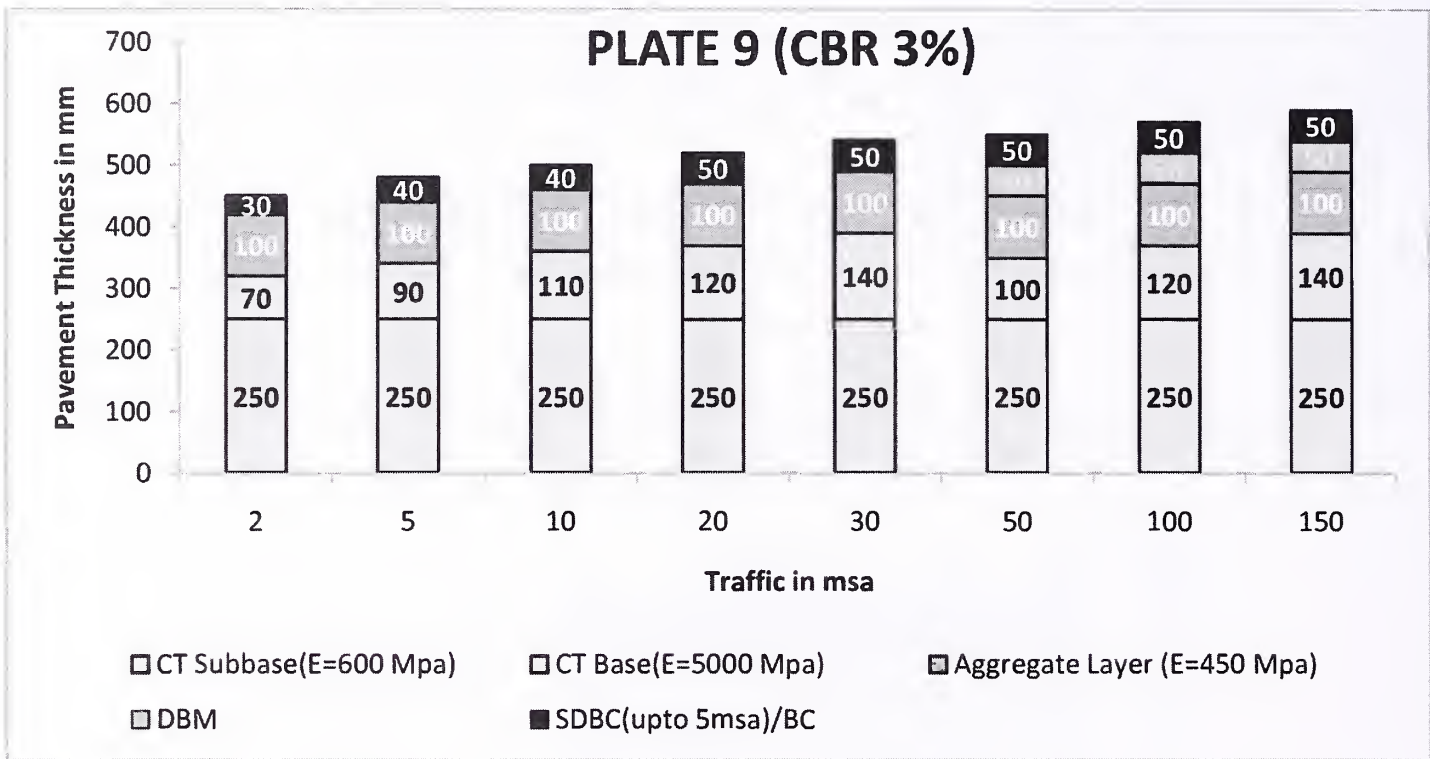


**Fig. 10.2 Bituminous Surfacing, Cement Treated Base and Cement Treated Sub-Base with Aggregate Interlayer**

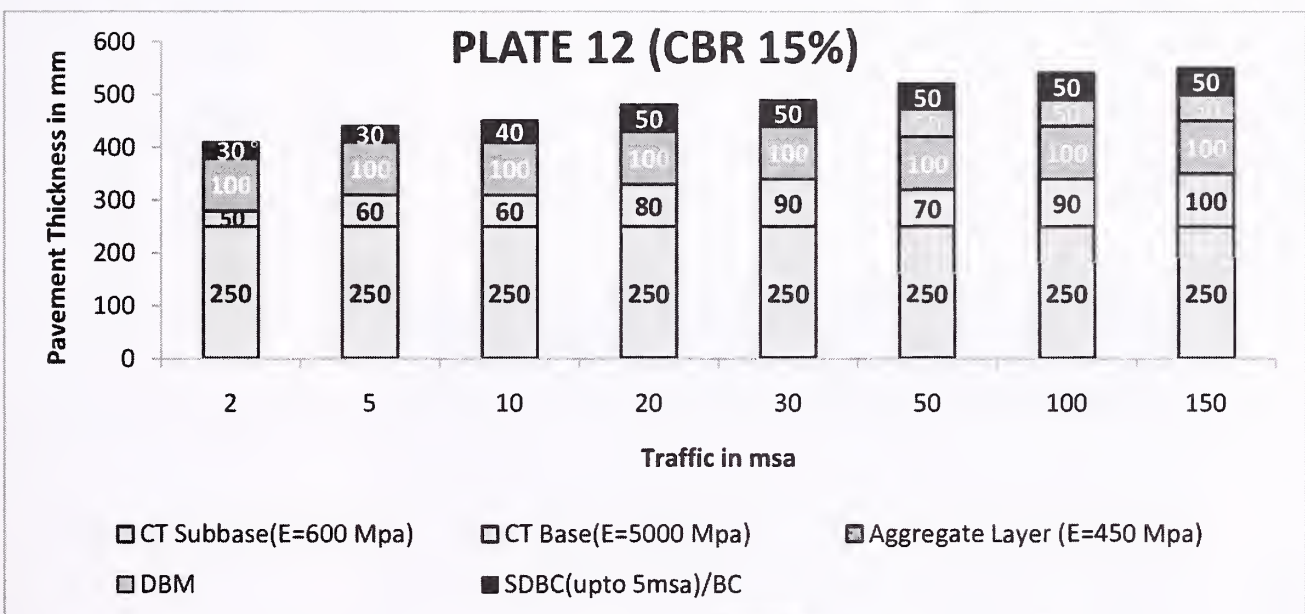
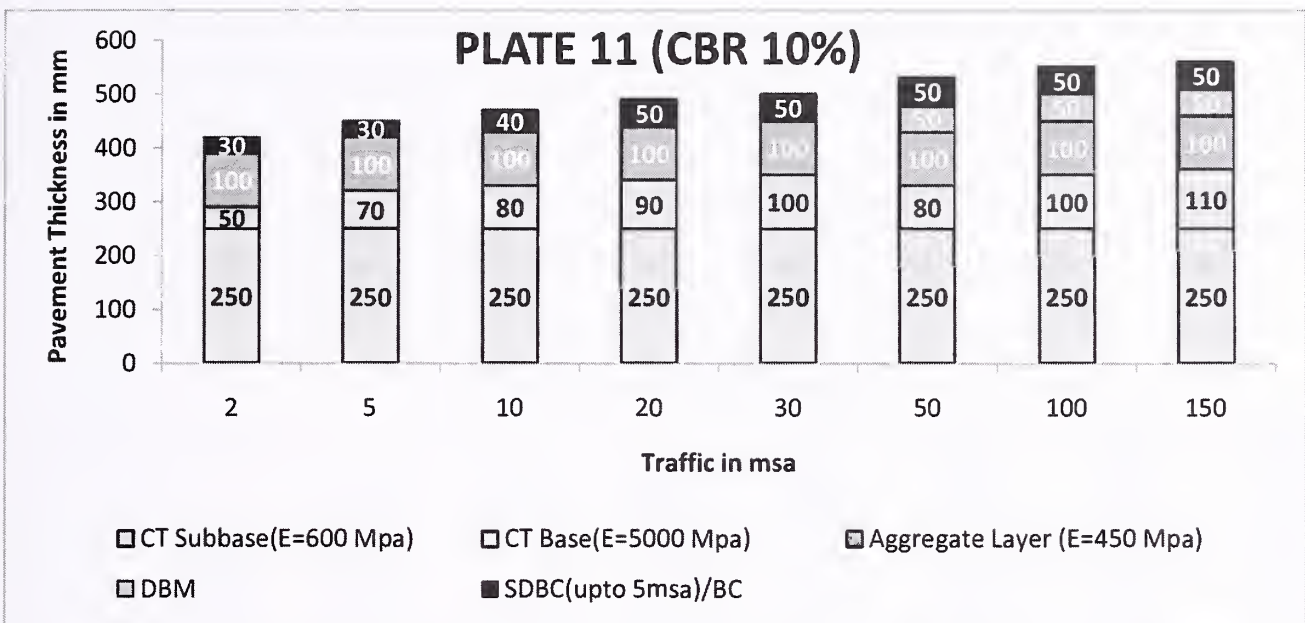
**Fig. 10.2** shows a five layer elastic structure consisting of bituminous surfacing, aggregate interlayer layer, cemented base, cemented subbase and the subgrade. Material properties such as modulus and poisson's ratio are the input parameters apart from loads and geometry of the pavement for the IITPAVE software. For traffic > 30 msa, VG 40 bitumen is used for preventing rutting. DBM has air void of 3 per cent after rolling (Bitumen content is 0.5 per cent to 0.6 per cent higher than the optimum). Cracking of cemented base is taken as the design life of a pavement. For traffic greater than 30 msa, minimum thickness of bituminous layer consisting of DBM and BC layers is taken as 100 mm (AASHTO-1993) even though the thickness requirement may be less from structural consideration. Residual life of the bituminous layer against fatigue cracking is not considered since it cracks faster after the fracture of the cemented base. Upper 100 mm of the cemented subbase (D) having the gradation 4 of the



Table V-1 of Annex V is porous acting as the drainage layer over lower cemented subbase (F). Coarse graded GSB of MORTH with fines less than 2 per cent containing about 2-3 per cent cement can also be used.







**Illustration**

**Traffic 150 msa**

Subgrade CBR = 10 per cent,  $M_{R \text{ subgrade}} = 17.6 \cdot \text{CBR}^{0.64} = 75 \text{ MPa}$ ,

$M_{R \text{ bituminous layer}} = 3000 \text{ MPa}$

Pavement composition for 90 per cent Reliability is BC + DBM = 100 mm,

Aggregate interlayer = 100 mm

(MR = 450 MPa), Cemented base = 110 mm (E = 5000 MPa), cemented subbase = 250 mm (600 MPa)

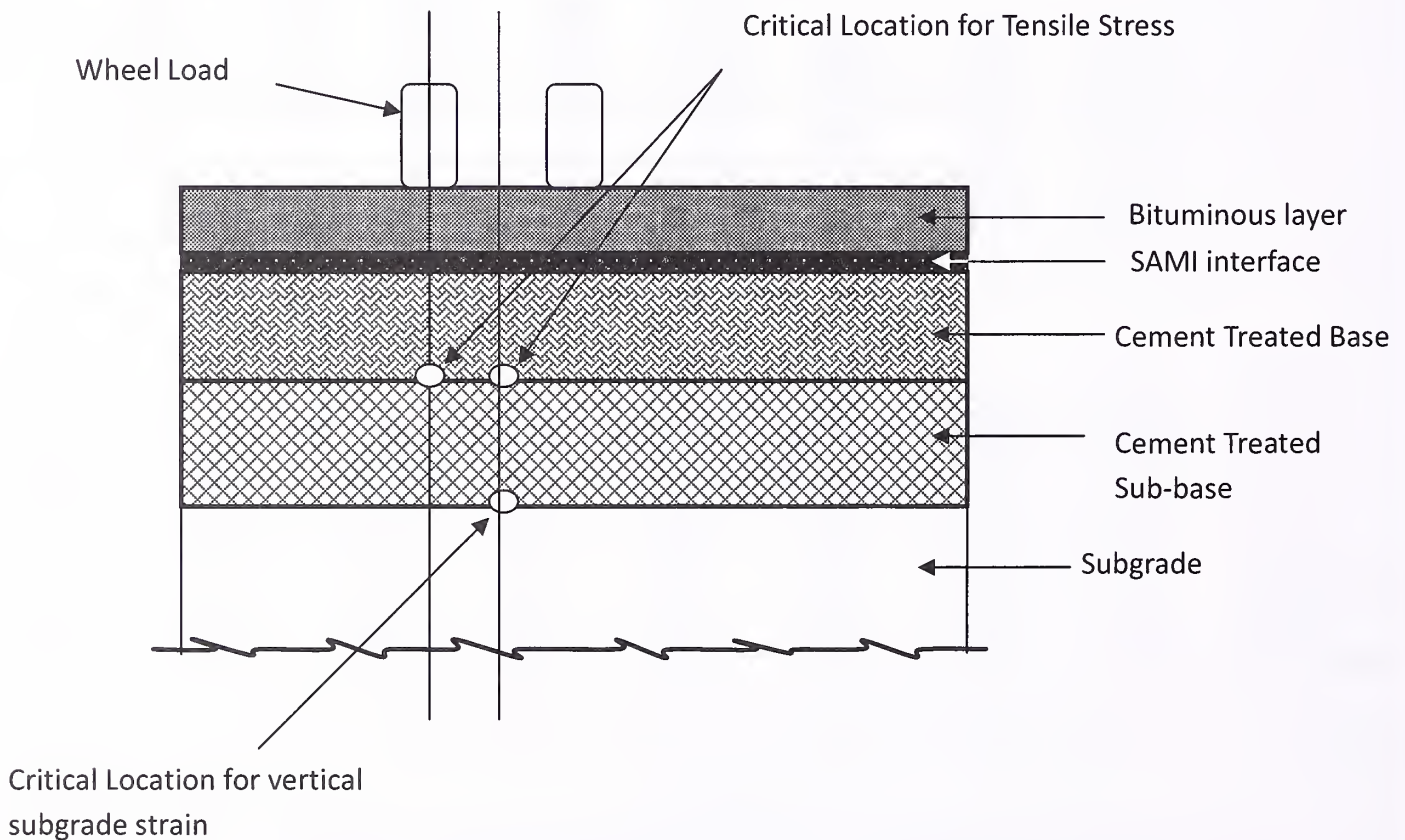
Equations 6.3, 6.5 and 6.6 are used as design criteria.

- (I) Allowable Horizontal Tensile Strain in Bituminous Layer is  $153 \times 10^{-6}$ .
- (II) Allowable Vertical Compressive Strain on Subgrade is  $291 \times 10^{-6}$ .
- (III) Allowable Tensile Strain in Cementitious Layer is  $64.77 \times 10^{-6}$ . From IITPAVE Software the computed strains are
  - (a) Horizontal Tensile Strain in Bituminous Layer is  $131 \times 10^{-6}$ .
  - (b) Vertical Compressive Strain on Subgrade is  $213 \times 10^{-6}$ .
  - (c) Tensile Strain in Cementitious Layer is  $52 \times 10^{-6}$

Hence the Pavement Composition is Safe. Design should also be checked for fatigue damage.

Minimum thickness bituminous layer for major highways is recommended as 100 mm as per the AASHTO 93 guidelines.

### 10.3 Cemented Base and Cemented Subbase with SAMI at the Interface of Cemented Base and the Bituminous Layer

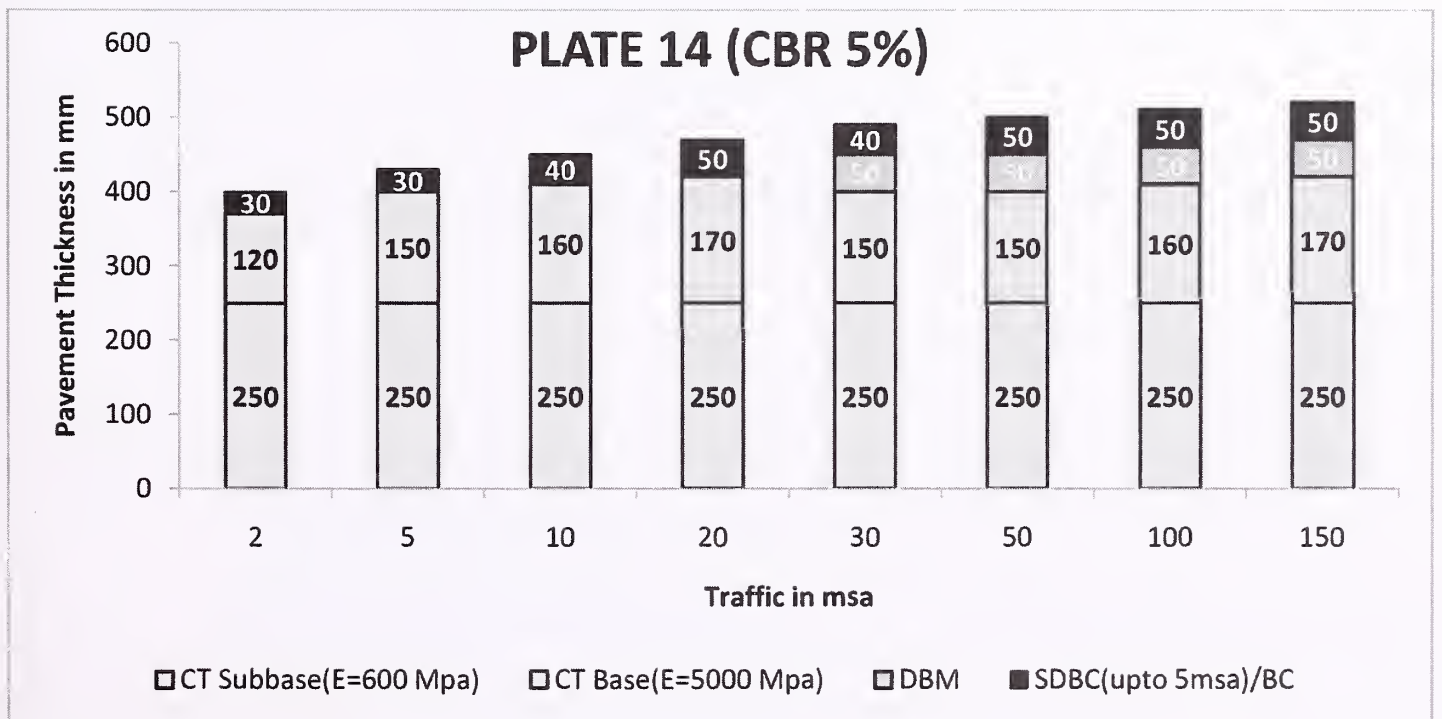
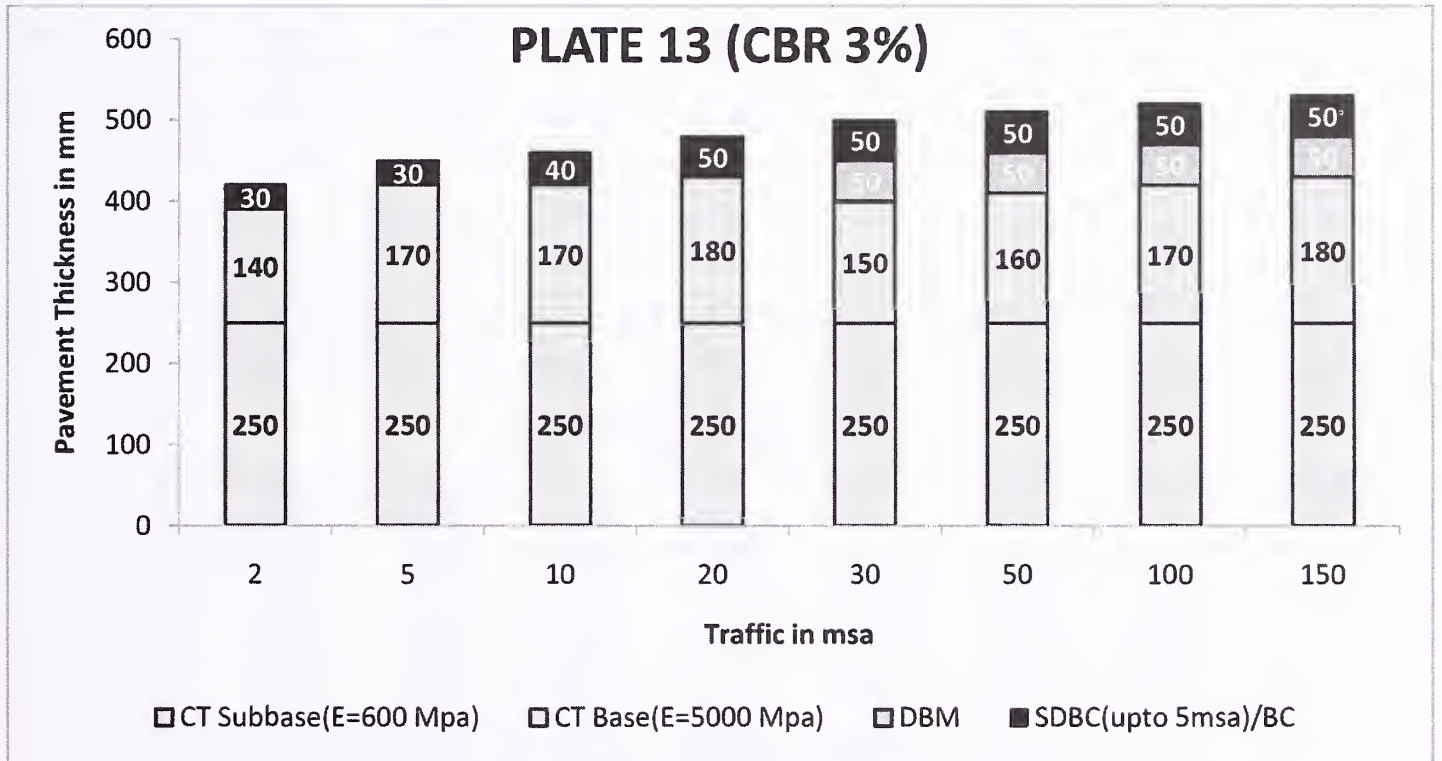


**Fig. 10.3 Bituminous Surfacing with Cemented Granular Base and Cemented Granular Sub-base with Stress Absorbing Membrane Interlayer (SAMI)**

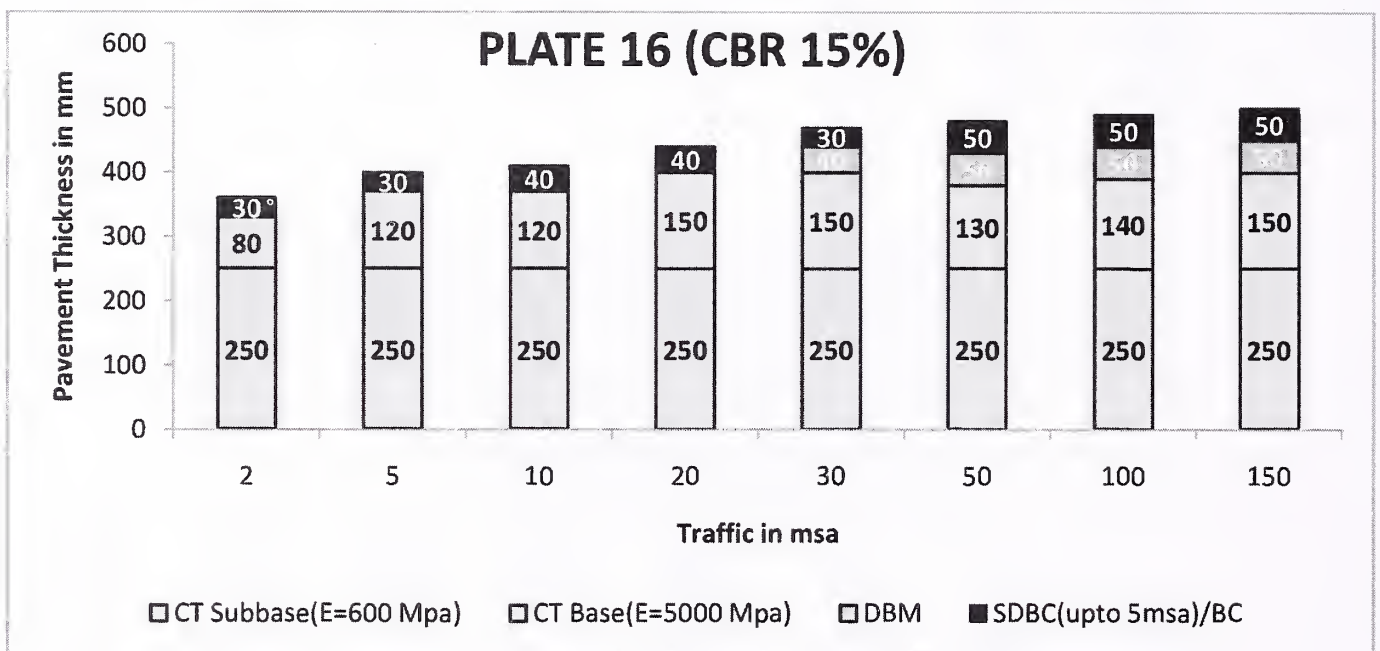
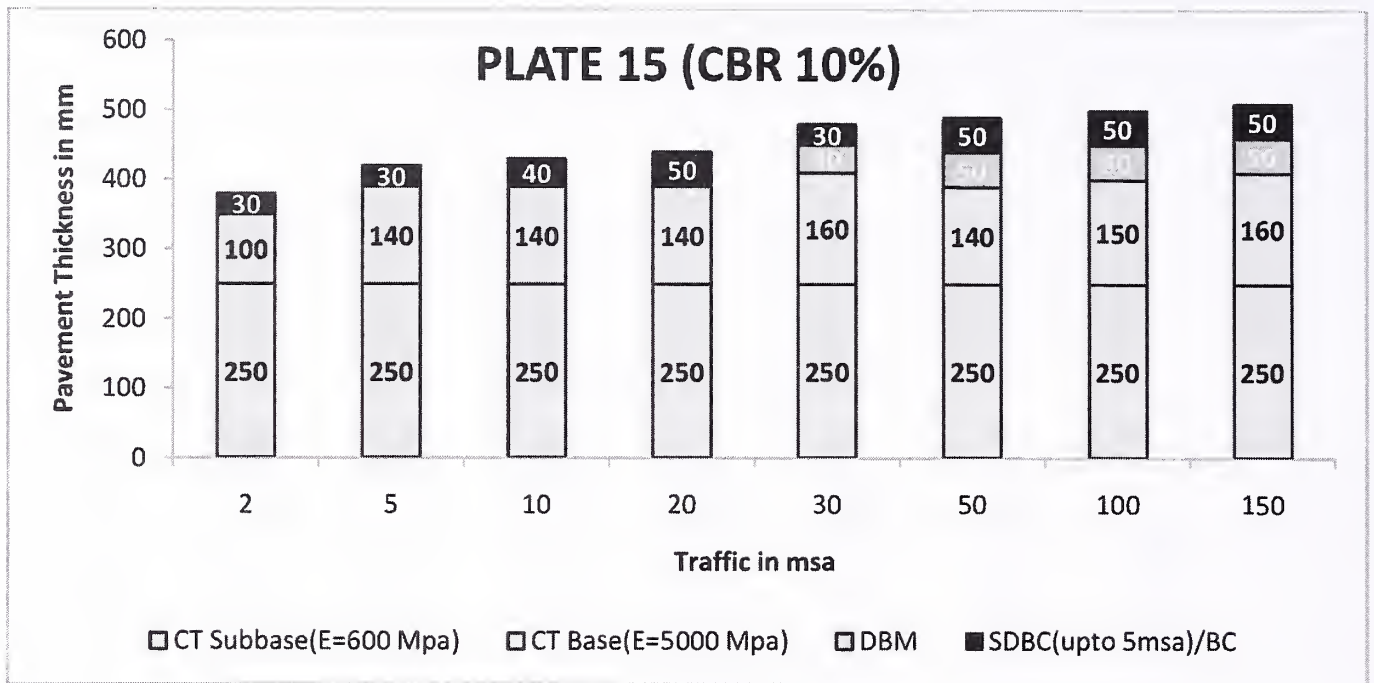
**Fig. 10.3** shows a four layer pavement consisting of bituminous surfacing, cemented base, cemented subbase and the subgrade. For traffic > 30 msa, VG 40 bitumen is used. DBM has air void of 3 per cent after rolling (Bitumen content is 0.5 per cent to 0.6 per cent higher

than the optimum). Cracking of cemented base is taken as the life of pavement. Minimum thickness of bituminous layer for major highways is recommended as 100 mm as per the AASHTO 93 guidelines. Stress on the underside of the bituminous layer over un-cracked cemented layer is compressive

Upper 100 mm of the cemented subbase having the gradation 4 of Table V-1 of Annex V is porous and functions as drainage layer over the cemented lower subbase.







**Illustration**

**Traffic 150 msa**

Subgrade CBR = 10%,  $M_{Rsubgrade} = 17.6 * CBR^{0.64} = 75 \text{ MPa}$ ,  $M_R \text{ bituminous layer} = 3000 \text{ MPa}$

E of cemented base = 5000 MPa, E of cemented subbase = 600 MPa

From PLATE 15, BC + DBM = 100 mm, Cemented base = 160 mm, Cemented subbase = 250 mm

SAMI is provided on the top of cemented base.



For the given composition of Pavement thicknesses, 90% Reliability is adopted i.e., Equations 6.3, 6.5 and 6.6 are used.

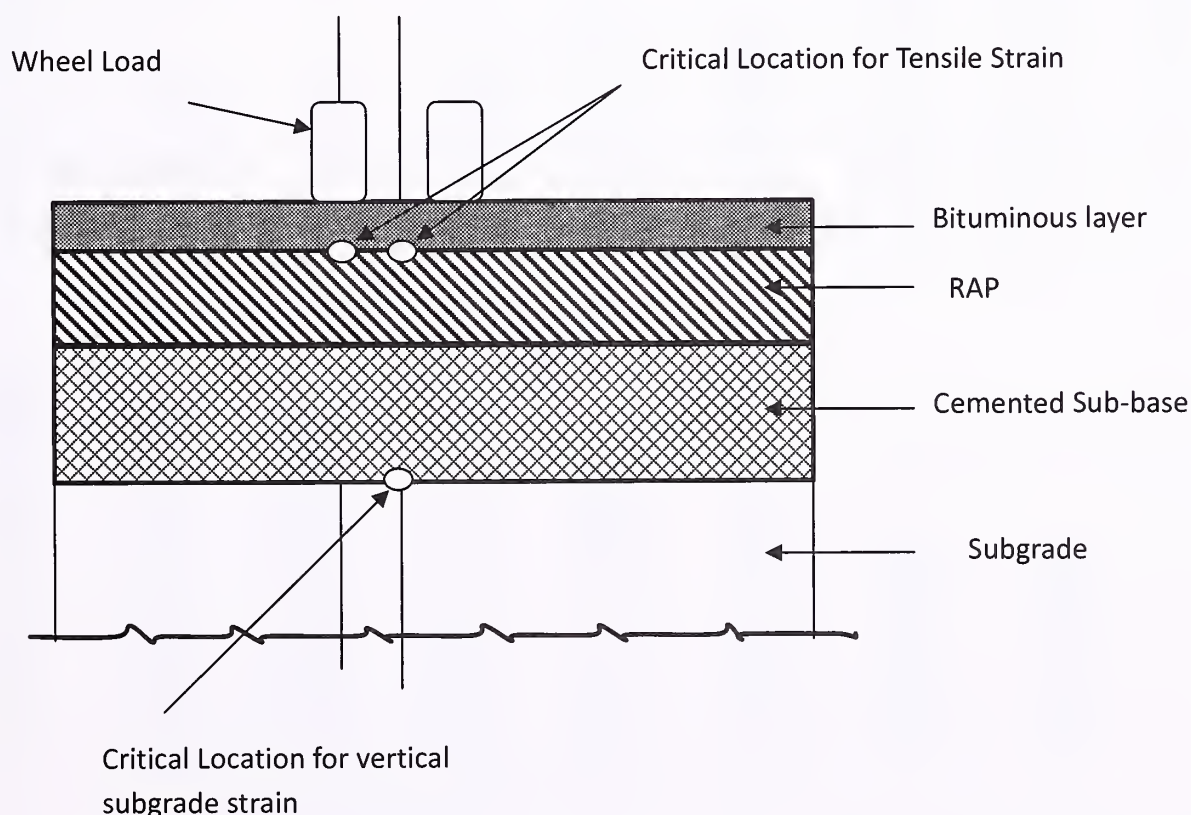
- (i) Allowable Horizontal Tensile Strain in Bituminous Layer is  $153 \times 10^{-6}$ .
- (ii) Allowable Vertical Compressive Strain on Subgrade is  $291 \times 10^{-6}$ .
- (iii) Allowable Tensile Strain in Cementitious Layer is  $64.77 \times 10^{-6}$ .

From IITPAVE Software the computed strains are

- (i) Horizontal Tensile Strain in Bituminous Layer is  $-4.2 \times 10^{-6}$  (Compressive).
- (ii) Vertical Compressive Strain on Subgrade is  $193 \times 10^{-6}$ .
- (iii) Tensile Strain in Cementitious Layer is  $58 \times 10^{-6}$ .

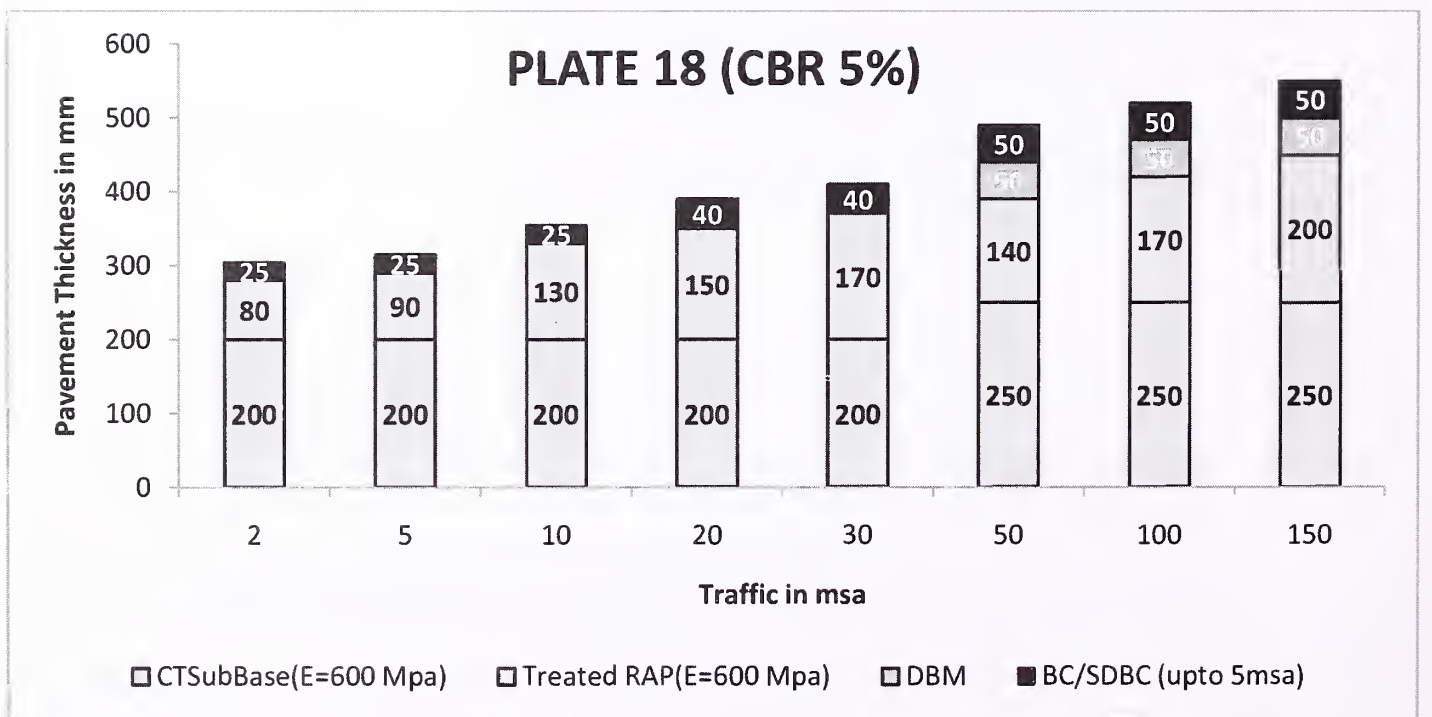
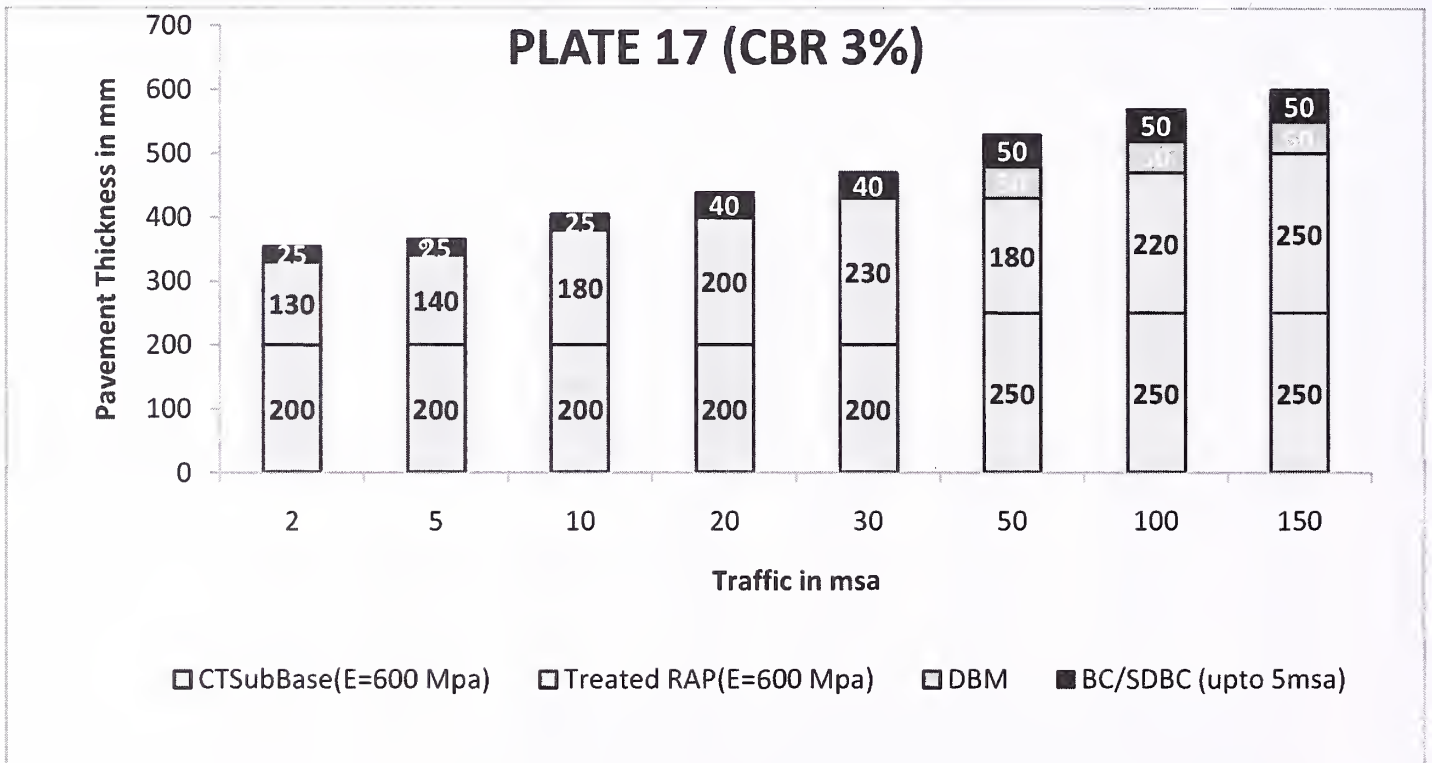
Minimum thickness of 100 mm has been adopted even though there is no tensile stress at the bottom as per AAHSTO 93 Guidelines. The Pavement Composition is safe. The reduction in thickness of the cemented base increases the bending stresses considerably because it is inversely proportional to the square of the thickness. Design should be checked against fatigue damage.

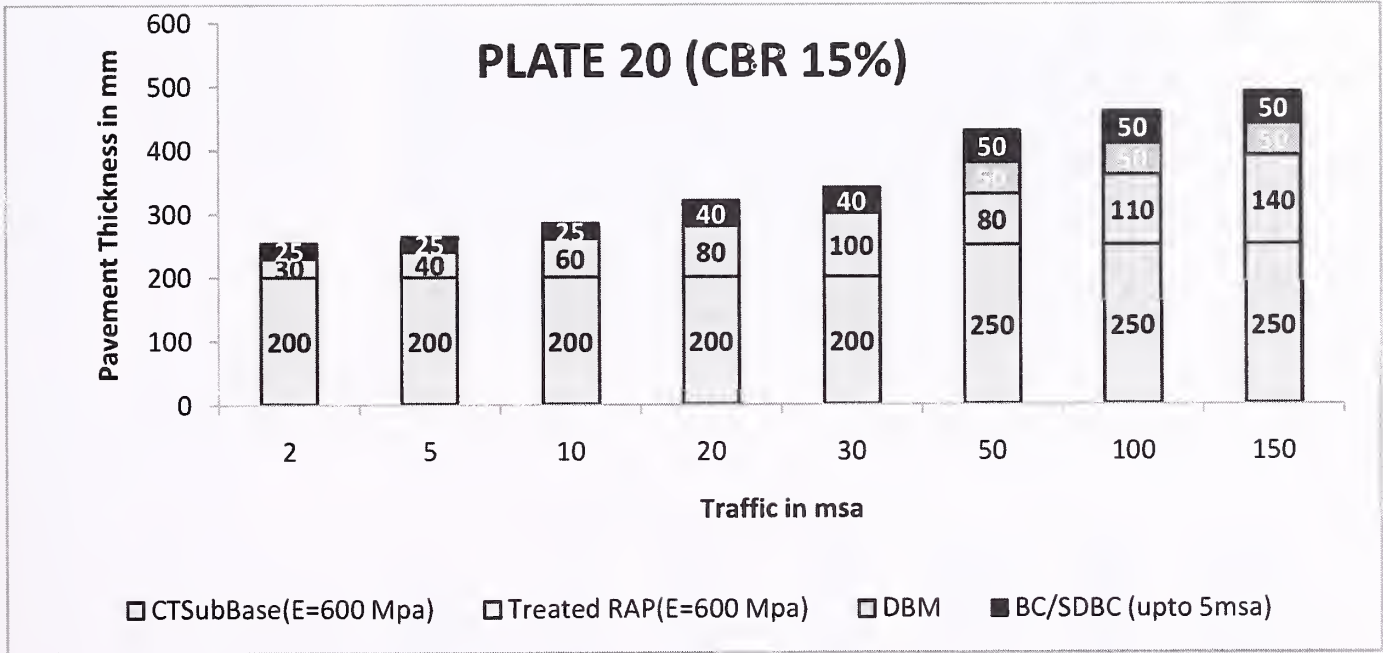
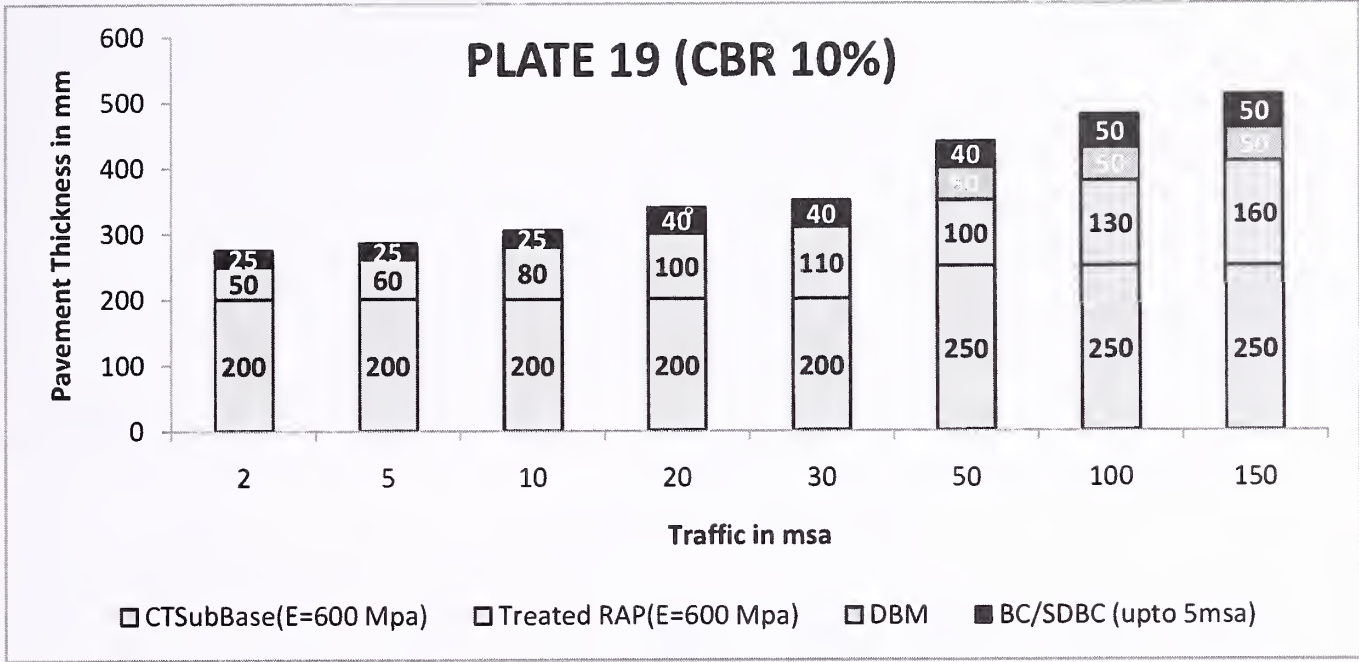
#### 10.4 Foamed Bitumen/Bitumen Emulsion Treated RAP/Aggregates Over Cemented Sub-base



**Fig. 10.4 Bituminous Surfacing with RAP and Cemented Sub-base**

Fig. 10.4 shows a four layer pavement consisting of bituminous surfacing, recycled layer Reclaimed asphalt pavement, cemented sub-base and the subgrade. VG 40 bitumen is used for traffic > 30 msa. Even bitumen emulsion/foamed bitumen treated fresh aggregates can be used to obtain stronger base of flexible pavements as per the international practice. DBM has air void of 3 per cent after rolling (Bitumen content is 0.5 per cent to 0.6 per cent higher than the optimum). Fatigue failure of the bituminous layer is the end of pavement life. Cemented sub-base is similar to that in Clause 9.3.





**Illustration**

**Traffic 150 msa**

Subgrade CBR = 10 per cent,  $E_{\text{subgrade}} = 17.6 \cdot \text{CBR}^{0.64} = 75 \text{ MPa}$ ,  $M_R$  bituminous layer = 3000 MPa

$M_R$  of RAP = 600 MPa, E of cemented sub-base = 600 MPa

Pavement thicknesses for CBR 10 per cent (PLATE 19), BC + DBM = 100 mm, RAP = 160 mm, cemented subbase = 250 mm

Design traffic = 150 msa 90 per cent Reliability is adopted i.e., Equations 6.3 and Equation 6.5 are used.



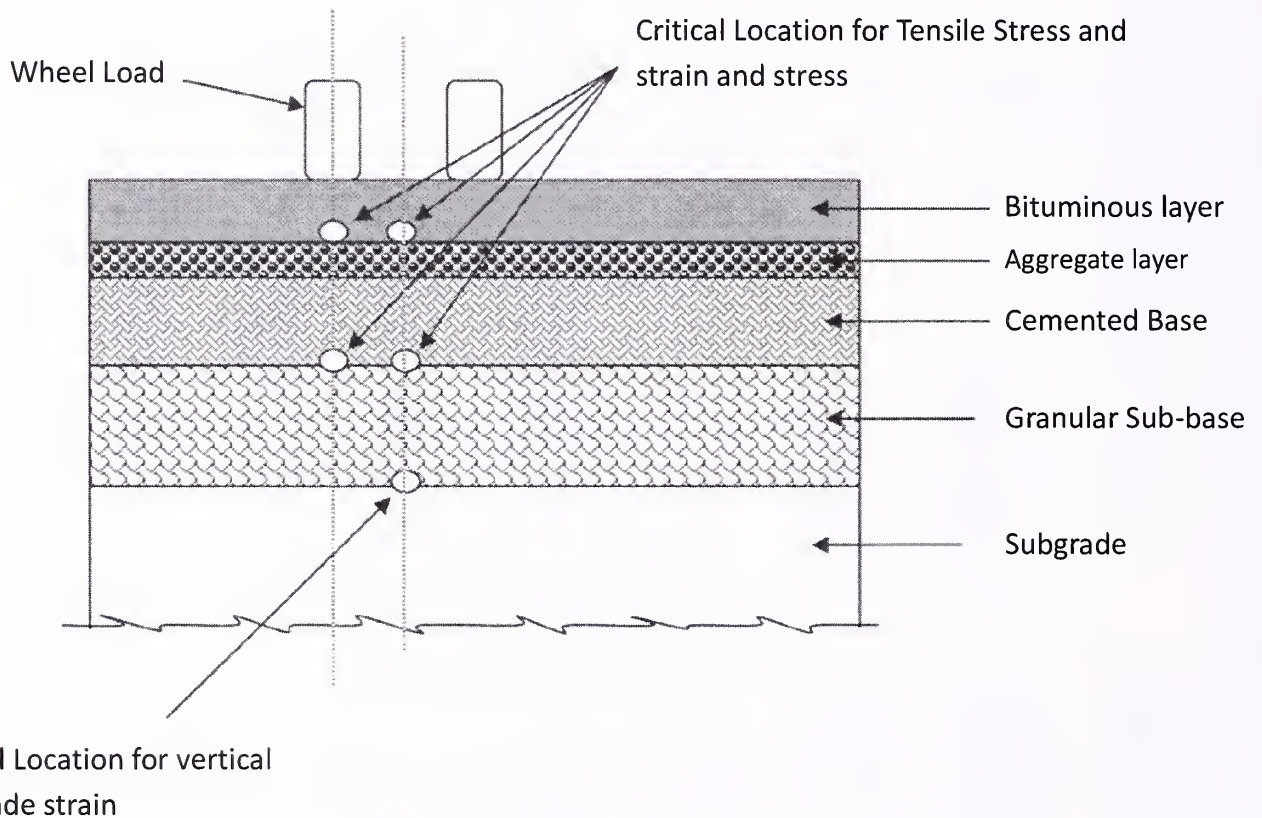
- (i) Allowable Horizontal Tensile Strain in Bituminous Layer is  $153 \times 10^{-6}$ .
- (ii) Allowable Vertical Compressive Strain on Subgrade is  $291 \times 10^{-6}$ .

From IITPAVE Software the computed strains are

- (i) Horizontal Tensile Strain in Bituminous Layer is  $131 \times 10^{-6}$ .
- (ii) Vertical Compressive Strain on Subgrade is  $277 \times 10^{-6}$ .

Minimum thickness of 100 mm has been adopted for traffic greater than 30 msa as per AAHSTO 93 Guidelines. Hence the Pavement Composition is Safe.

### 10.5 Cemented Base and Granular Sub-base with Crack Relief Layer of Aggregate Interlayer Above the Cemented Base

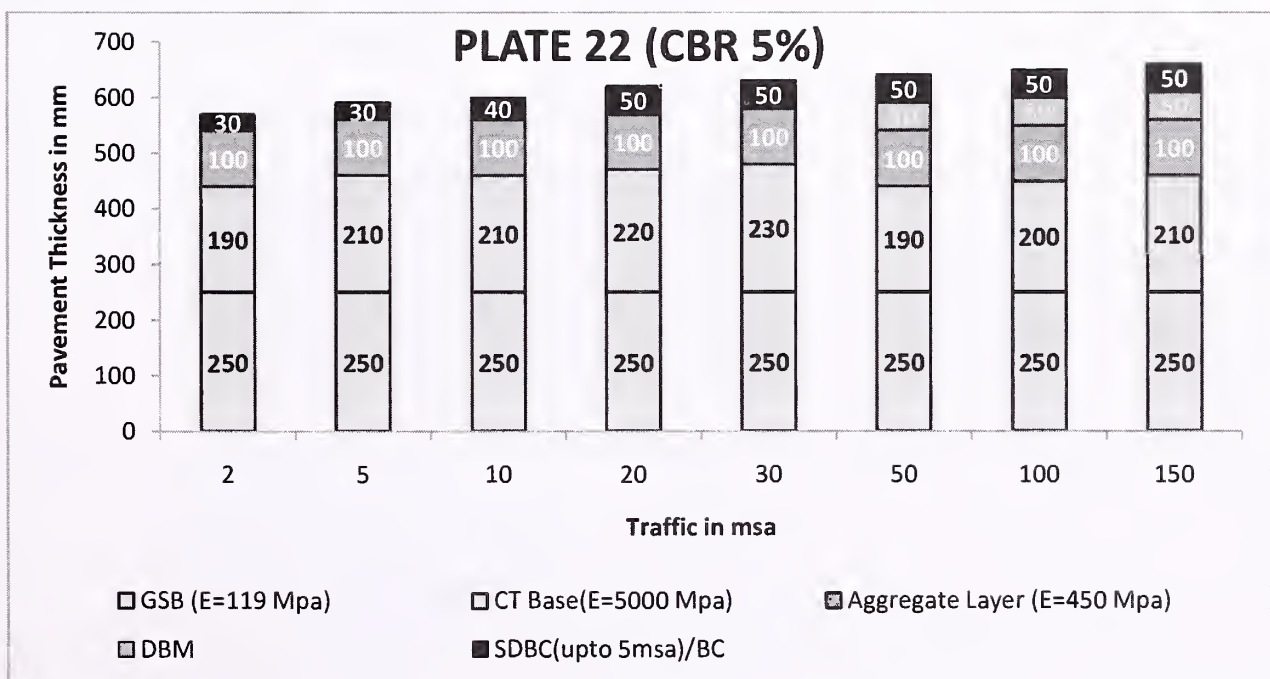
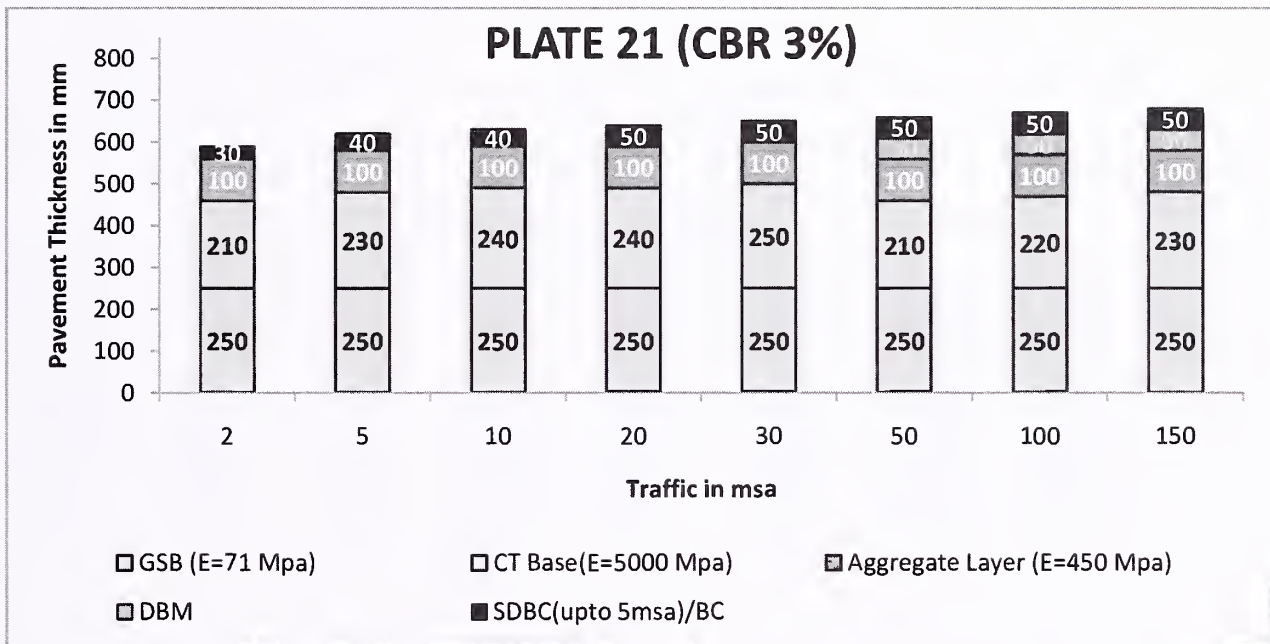


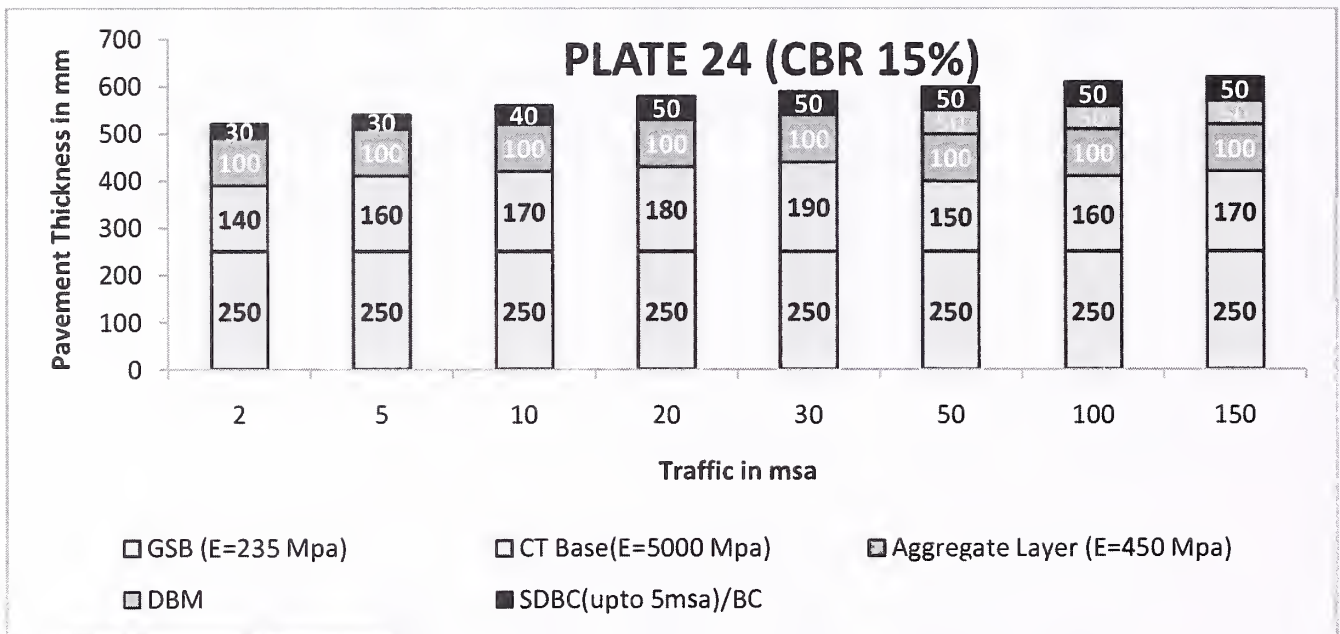
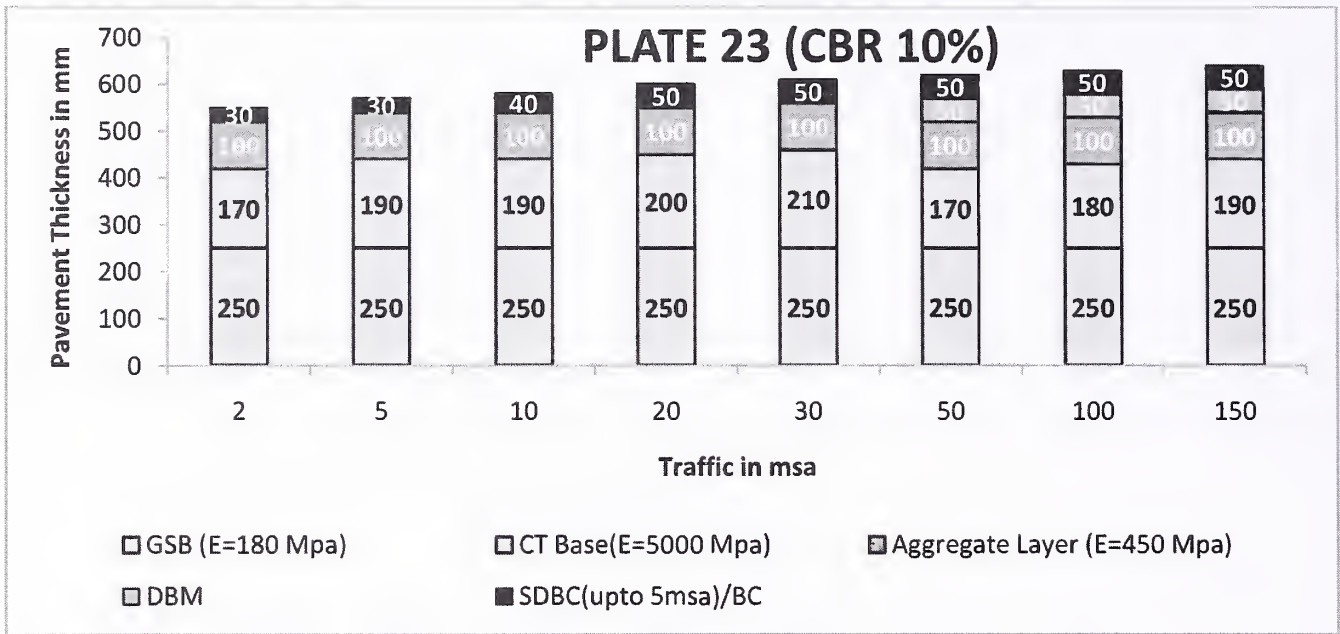
**Fig. 10.5 Bituminous Surfacing, Cement Treated Base and Granular Sub-base with Aggregate Interlayer**

For reconstruction of a highway, designers may have a choice of bituminous surface, aggregate interlayer, cemented base while retaining the existing granular subbase. The drainage layer in GSB is required to be restored in area where rainfall may damage the pavements. It is modelled as a five layer elastic structure in IITPAVE software. In a two layer construction of bituminous layer, the bottom layer should have an air void of 3 per cent after the compaction by incorporating additional bitumen of 0.5 to 0.6 per cent. This would also resist stripping due to water percolating from the top to the bottom of the bituminous layer



or rising from below. The aggregate interlayer acting as a crack relief layer should meet the specifications of Wet Mix Macadam and if required, it may contain about 1 to 2 per cent bitumen emulsion if the surface of the granular layer is likely to be disturbed by construction traffic. Emulsion can be mixed with water to make the fluid equal to optimum water content and added to the WMM during the processing. The granular sub-base should consist of drainage (grading 4 of Annex V, Table V-1) as well as filter/separation layer. Upper 100 mm of GSB is drainage layer having a permeability of 300 metre/day. A reliability of 80 per cent is used for traffic up to 30 msa and 90 per cent for traffic > 30 msa. VG 30 bitumen is recommended for traffic up to 30 msa and VG 40 for traffic > 30 msa. For colder area, recommendation of IRC: 111-2009 shall be followed. The different catalogue of thicknesses is:





**Illustration**

**Traffic 150 msa**

Subgrade CBR = 10 per cent,  $M_{Rsubgrade} = 17.6 \times CBR^{0.64} = 75 \text{ MPa}$ ,  $M_R$  of bituminous layer = 3000 MPa

$M_R$  of Aggregate layer = 450 MPa, E of cemented base = 5000 MPa, E of granular sub-base =  $75 \times (0.2) \times (250)^{0.45} = 179.955 = 180 \text{ MPa}$

From PLATE 23, Pavement composition BC + DBM = 100 mm, Aggregate interlayer = 100 mm, cemented base = 190 mm, granular subbase = 250 mm

For the given composition of Pavement thicknesses, 90 per cent Reliability is adopted i.e., Equation 6.3, Equation 6.5 and Equation 6.6 are used.

- (i) Allowable Horizontal Tensile Strain in Bituminous Layer is  $153 \times 10^{-6}$ .
- (ii) Allowable Vertical Compressive Strain on Subgrade is  $291 \times 10^{-6}$ .
- (iii) Allowable Tensile Strain in Cementitious Layer is  $64.77 \times 10^{-6}$ .

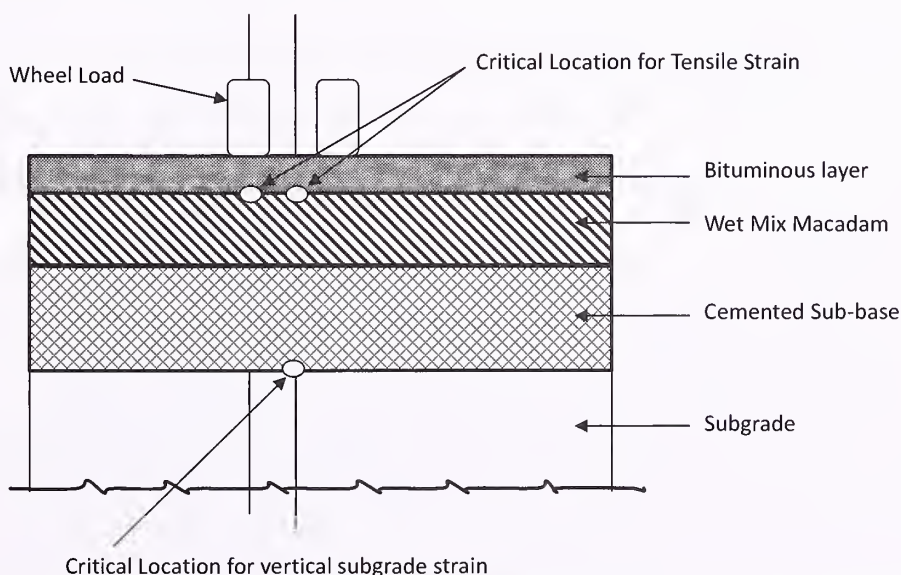
From IITPAVE Software the computed strains are

- (i) Horizontal Tensile Strain in Bituminous Layer is  $127 \times 10^{-6}$ .
- (ii) Vertical Compressive Strain on Subgrade is  $165.4 \times 10^{-6}$ .
- (iii) Tensile Strain in Cementitious Layer is  $63.6 \times 10^{-6}$ .

Hence the Pavement Composition is Safe.

## 10.6 Other Pavement Compositions

There can be large number of combinations for a good pavement depending upon the availability of materials. A strong subgrade and a strong subbase which are non-erodible over a period of time due to pore water pressure are very important for a good performing pavement. Use of cemented subbase of lower strength having strength from 1.5 MPa to 3 MPa with thick bituminous layer is common in South Africa (66) in dry area. In wet regions, such low strength cemented subbases with granular layer and wearing course of bituminous concrete is used up to 30 msa. Though PLATES for combinations are not provided, two examples are presented below illustrating how to work out thickness of such pavements with a cemented subbase, Wet Mix Macadam base and bituminous surfacing. NH-8 from Ahmedabad to Jodhpur has cemented layer below the Wet Mix Macadam. **Fig. 10.6** shows a combination of bituminous pavements with WMM base and cemented granular subbase with strength 1.5 MPa to 3.0 MPa. Cement bound granular subbase Grading IV of IRC:SP-89 having strength in the range 0.75-1.5 MPa is not recommended for major highways as per South African practice but it can be used for others if the design traffic less than 10 msa.



**Fig. 10.6 Bituminous Surfacing with Wet Mix Macadam Base and Cemented Sub-base**



**Illustration 1**

Traffic = 100 msa, Subgrade CBR = 8 per cent, Pavement Composition: Trial Bituminous layer (BC + DBM) = 120 mm, WMM base = 150 mm, Cemented sub-base (1.5-3.0 MPa strength) = 300 mm.

For 8 per cent CBR, modulus of subgrade =  $17.6 \times 8^{0.64} = 66$  MPa,  $M_R$  bituminous layer = 3000 MPa,  $M_R$  WMM = 350 MPa since support is weak,  $M_R$  is taken as 450 MPa over stronger cemented layer of Modulus 5000 MPa in PLATE 9.

$$E_{\text{cemented sub-base}} = 600 \text{ MPa.}$$

For 90 per cent reliability,

Allowable Tensile strain on the bottom of Bituminous layer ( $\epsilon_t$ ) =  $169.96 \times 10^{-6}$

Allowable Compressive strain on the top of subgrade ( $\epsilon_z$ ) =  $318.9 \times 10^{-6}$

For the above thickness, the strains at the critical locations calculated by IITPAVE software are:

Tensile strain at the bottom of Bituminous Layer ( $\epsilon_t$ ) =  $139 \times 10^{-6}$

Compressive strain on the top of subgrade ( $\epsilon_z$ ) =  $248 \times 10^{-6}$

Thickness can be optimized by different trials. Low strength cemented sub-base without a strong cemented base is not suitable for Wet areas.

**Illustration 2**

Traffic = 5 msa, Subgrade CBR = 8 per cent, Pavement Composition: Bituminous layer (BC + DBM) = 75 mm, WMM base = 100 mm, Cemented sub-base = 150 mm.

For 8 per cent CBR, modulus of subgrade =  $17.6 \times 8^{0.64} = 66$  MPa, E

$$M_R \text{ bituminous layer} = 1700 \text{ MPa, } M_R \text{ WMM} = 350 \text{ MPa,}$$

$$E_{\text{cemented sub-base}} = 600 \text{ MPa}$$

For 80 per cent reliability,

Allowable Tensile strain on the bottom of Bituminous layer ( $\epsilon_t$ ) =  $425.5 \times 10^{-6}$

Allowable Compressive strain on the top of subgrade ( $\epsilon_z$ ) =  $784.3 \times 10^{-6}$

For the above thickness, the strains at the critical locations calculated by IITPAVE software are:

Tensile strain at the bottom of Bituminous Layer ( $\epsilon_t$ ) =  $230 \times 10^{-6}$

Compressive strain on the top of subgrade ( $\epsilon_z$ ) =  $665 \times 10^{-6}$

Thickness can be optimized by different trials.

## 11 INTERNAL DRAINAGE IN PAVEMENT

**11.1** The performance of a pavement can be seriously affected if adequate drainage measures to prevent accumulation of moisture in the pavement structure are not taken. Some of the measures to guard against poor drainage conditions are maintenance of transverse section in good shape to reasonable crossfall so as to facilitate quick run-off of surface water and provision of appropriate surface and sub-surface drains where necessary. Drainage measures are especially important when the road is in cutting or built on low permeability soil or situated in heavy rainfall/snow fall area.

**11.2** On new roads, the aim should be to construct the pavement as far above the water table as economically practicable. The difference between the bottom of subgrade level and the level of water table/high flood level should, generally, not be less than 1.0 m or 0.6 m in case of existing roads which have no history of being overtopped. In water logged areas, where the subgrade is within the zone of capillary saturation, consideration should be given to the installation of suitable capillary cut-off as per IRC:34 at appropriate level underneath the pavement.

**11.3** When the traditional granular construction is provided on a relatively low permeability subgrade, the granular sub-base should be extended over the entire formation width in order to drain the pavement structural section. Care should be exercised to ensure that its exposed ends do not get covered by the embankment soil. The trench type section should not be adopted in any case, in absence of special drainage measures it would lead to the entrapment of water in the pavement structure.

**11.4** If the granular sub-base is of softer variety which may undergo crushing during rolling leading to denser gradation and low permeability, the top 100 to 150 mm thickness should be substituted by an open graded crushed stone layer of Los Angeles abrasion value not exceeding 40 to ensure proper drainage.

The filter layer must have enough permeability to prevent development of undesirable pore water pressure and it should drain away any free water that enters into it albeit at much lower rate as compared to the drainage layer.

The filter/separation layer should satisfy the following criteria:

$$\frac{D_{15} \text{ of filter layer}}{D_{15} \text{ of subgrade}} \geq 5 \quad \dots \text{ 11.1}$$

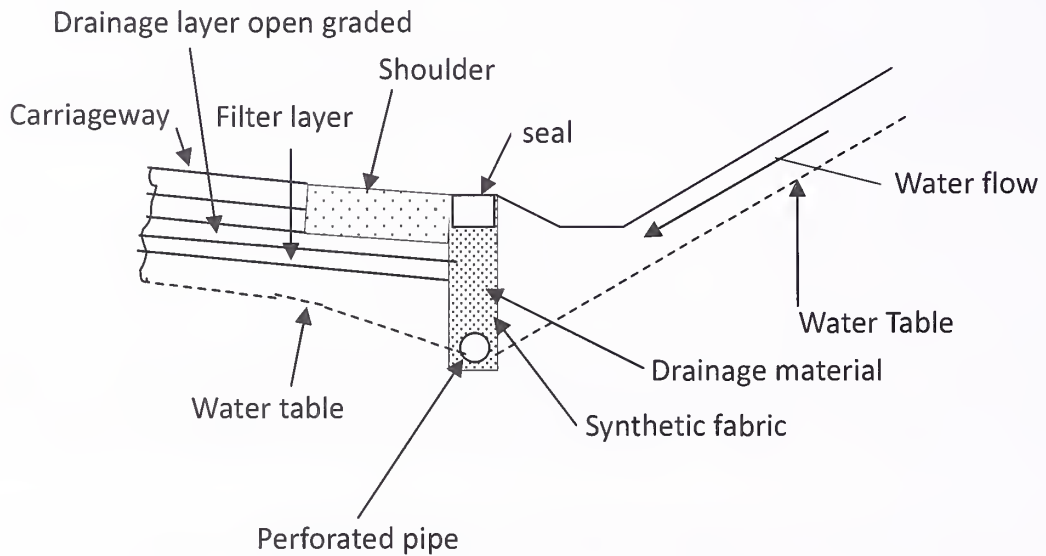
$$\frac{D_{15} \text{ of filter layer}}{D_{85} \text{ of subgrade}} \leq 5 \quad \dots \text{ 11.2}$$

To prevent entry of soil particles into the drainage layer

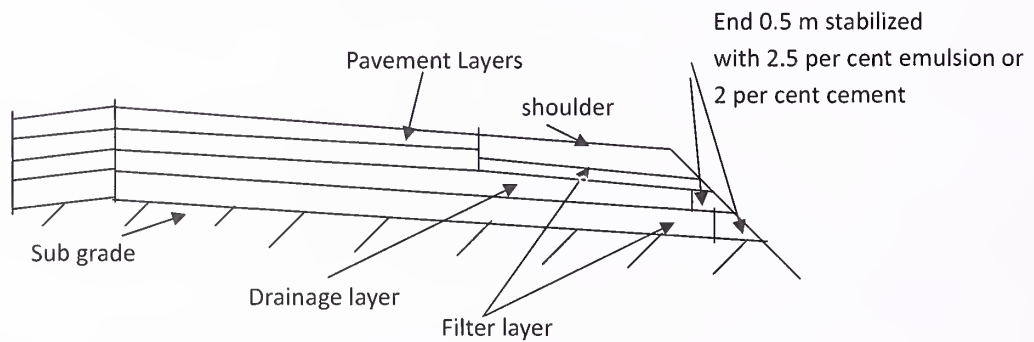
$$\text{and} \quad \frac{D_{50} \text{ of filter layer}}{D_{50} \text{ of subgrade}} \leq 25 \quad \dots \text{ 11.3}$$

$D_{85}$  means the size of sieve that allows 85 per cent by weight of the material to pass through it. Similar is the meaning of  $D_{50}$  and  $D_{15}$ .

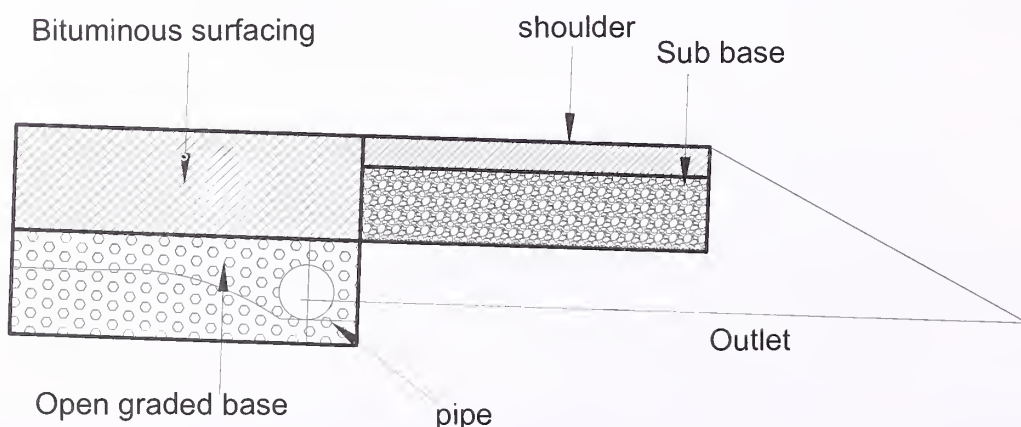
The permeable sub-base when placed on the erodible subgrade soil should be underlain by a layer of filter material to prevent the intrusion of soil fines into the drainage layer (Fig. 11.2). Non-woven geosynthetic also can be provided to act as a filter/separation layer. Some typical drainage system is illustrated in Figs. 11.1, 11.2 and 11.3.



**Fig. 11.1 Pavement along a Slope**



**Fig. 11.2 Pavement with Filter and Drainage Layers**



**Fig. 11.3 Longitudinal Pipe at the Edge of the Drainage Layer with Outlet Pipe**



**11.5** When large inflows are to be taken care of, an adequately designed sub-surface drainage system consisting of an open graded drainage layer with collection and outlet pipes should be provided. The system should be designed on a rational basis using seepage principles to estimate the inflow quantities and the outflow conductivity of the drainage system. It should be ensured that the outflow capabilities of the system are at least equal to the total inflow so that no free water accumulates in the pavement structural section. If granular sub-base is not required because of strong subgrade, commercially available geocomposite can be used for drainage and separation. A design example is given in **Annex V**.

**11.6** Very often, water enters the base, sub-base or the subgrade at the junction of the verges and the bituminous surfacing. To counteract the harmful effects of this water, it is recommended that the shoulders should be well-shaped and if possible, constructed of impermeable material. Major highways should have paved shoulder to keep away water from the subgrade and for other roads also with design traffic of 20 msa or less; the base should be constructed 300-450 mm wider than the required bituminous surfacing so that the run-off water disperses harmlessly well clear off the main carriageway.

**11.7** Shoulders should be accorded special attention during subsequent maintenance operation too. They should be dressed periodically so that they always conform to the requisite cross-fall and are not higher than the level of carriageway at any time.

### **11.8 Drainage Requirement**

Heavy axle loads commonly ply on major roads in India and therefore, it should be ensured that the unbound layers do not undergo unacceptable permanent deformation under repeated loading. The subgrade and the granular layers with entrapped water would be subjected to large pore water pressure under heavy loads causing erosion of the unbound layer. It is necessary to provide a drainage layer to drain away the water entering into the pavement. The coarse graded granular sub-base (62) would have the necessary permeability of 300 m/day with per cent fines passing 0.075 mm sieve less than 2 per cent. Laboratory test should be conducted for the evaluation of the permeability of the drainage layer. If the surface of the open graded drainage layer is likely to be disturbed by the construction traffic the layer may be treated with 2 per cent cement/2-2.5 per cent of bituminous emulsion without any significant loss of permeability. Field test by Ridgeway in USA indicated that it is the duration of low intensity sustained rainfall rather than high intensity rainfall that is critical for infiltration of water into the pavement. It was found that the infiltration rate through the cracks was 0.223 m<sup>3</sup>/day/m and this value can be used for design of drainage layer in the absence of field data. The infiltration rate per unit area  $q_i$  in m<sup>3</sup>/day/m<sup>2</sup> can be expressed as:

$$q_i = I_c \left( \frac{N_c}{W_p} + \frac{W_c}{C_s W_p} \right) + K_p \quad \dots 11.4$$

Where,

- $I_c$  = Crack infiltration rate (0.223 m<sup>3</sup>/day/m)
- $N_c$  = Number of longitudinal cracks (i.e., number of lanes plus one)
- $W_p$  = Width of pavement subjected to infiltration
- $W_c$  = Length of the transvers cracks (equal to the width of the pavement)
- $C_s$  = Spacing of transverse cracks (taken as 12 m for bituminous pavement)
- $K_p$  = Rate of infiltration through uncracked area (assumed zero for thick bituminous pavements)

An example for the design of drainage layer is given in **Annex V**.

## 12 DESIGN IN FROST AFFECTED AREAS

**12.1** In areas susceptible to frost action, the design will have to be related to actual depth of penetration and severity of the frost. At the subgrade level, fine grained clayey and silty soils are more susceptible to ice formation, but freezing conditions could also develop within the pavement structure if water has a chance of ingress from above.

**12.2** One remedy against frost attack is to increase the depth of construction to correspond to the depth of frost penetration, but this may not always be economically practicable. As a general rule, it would be inadvisable to provide total thickness less than 450 mm even when the CBR value of the subgrade warrants a smaller thickness. In addition, the materials used for building up the crust should be frost resistant.

**12.3** Another precaution against frost attack is that water should not be allowed to collect at the subgrade level which may happen on account of infiltration through the pavement surface or verges or due to capillary rise from a high water table. Whereas capillary rise can be prevented by subsoil drainage measures and cut-offs, infiltrating water can be checked only by providing a suitable wearing surface.

## 13 SUMMARY OF PAVEMENT DESIGN PROCEDURE AND USE OF IITPAVE SOFTWARE

The analysis and design of pavement may be carried out by the following approach:

- A. For traffic lower than 2 msa, recommendation of IRC:SP:72-2007 may be used.
- B. In case of higher traffic, IITPAVE software may be used. It is a multilayer elastic layer analysis programme. This software is included along with the Pavement

Design Guidelines in a CD. Details and method of data inputs are self explanatory CD. The necessary steps required to use this software are:

- (i) Open the folder IRC\_37\_IITPAVE.
- (ii) Double-click IITPAVE\_EX file in the IRC\_37\_IITPAVE folder. This is an executable jar file. A home screen will appear.
- (iii) From the Home screen user can manually give input through input window by clicking on 'Design New Pavement Section'. User can also give input through properly formatted input file by clicking on 'Edit Existing File' option then browsing and opening the input file.
- (iv) Next an input window will come. All the inputs required have to be given through that input window.
- (v) First, number of layers to be selected from drop down menu to fix up input boxes for different layer inputs.
- (vi) Next, Elastic modulus (E) values of the various layers in MPa, Poisson's ratio and thickness of various layers in mm excluding the subgrade thickness are to be provided.
- (vii) Single wheel load and the tyre pressure are to be provided (tyre pressure of 0.56 MPa has been used for calibration of the fatigue equation and the same pressure can be used for stress analysis. Change of pressure even up to 0.80 MPa has a small effect upon stress values in lower layers.)
- (viii) Then the number of points for stress computations is to be given through the drop down menu for analysis points.
- (ix) Then corresponding to different points, the values of depth Z in mm and the corresponding value of radial distance from wheel centre (r) in mm are to be given.
- (x) Provide whether analysis is for single wheel load or dual wheel load by selecting 1 or 2 from drop down menu beside "Wheel Set". Only dual wheel load may be needed in most cases.
- (xi) The output of the programme will provide stresses, strains and deflections at the desired points. Next check if the computed strains are less than the permissible strain. If not then run the program with a new thickness combinations till the permissible strain values are achieved.  $\epsilon_T$ ,  $\epsilon_R$  and  $\epsilon_Z$  will be the outputs that will be of interest. For cemented base tensile stress below the cemented layer  $\sigma_T/\sigma_R$  are needed for cumulative fatigue damage analysis.



- (xii) In most cases the tensile strain at the bottom of the bituminous layer is higher in the longitudinal direction ( $\epsilon_{pT}$ ) rather than in radial direction ( $\epsilon_{pR}$ ). If tensile strain in the bituminous layer is high, increase the thickness of the bituminous layer.
- (xiii) Tensile strains in the cementitious bases also are to be computed for design. If the tensile strain/stress in the cemented layer is higher, increase the thickness of the cemented layer.
- (xiv) Vertical subgrade strain ( $\epsilon_{pZ}$ ) should be less than the permissible value for the design traffic. If the vertical subgrade strain is higher, increase the thickness of sub-base layer.
- (xv) Stress values can also be easily computed by changing directly the input file which is to be written in a format as illustrated in the manual and browse the input file by clicking 'Edit Existing File' on home screen of IITPAVE.

The above approach can be used to arrive at the pavement thickness satisfying the limiting strains.

C. Design charts are provided in the text of the guidelines. The software can help in finding the thickness for any traffic other than that given in the design catalogue. The method of arriving at the design catalogue is illustrated in the plates for each type of pavement combination.

## ANNEX-I

(Refer Clause 6.2.2)

### Considerations in Design of Bituminous Pavements

**I-1:** The IITPAVE software is capable of analyzing a multilayer layer elastic system with rough interfaces. Vertical subgrade strain,  $\epsilon_v$ , is an index of bearing capacity of the subgrade and it needs to be kept below a certain value for a given traffic to limit rutting in the subgrade and granular layers of a well constructed pavement. Research findings indicate that the plastic vertical strain,  $\epsilon_p$ , in pavement materials depends upon the magnitude of elastic vertical strain,  $\epsilon_v$ , given as

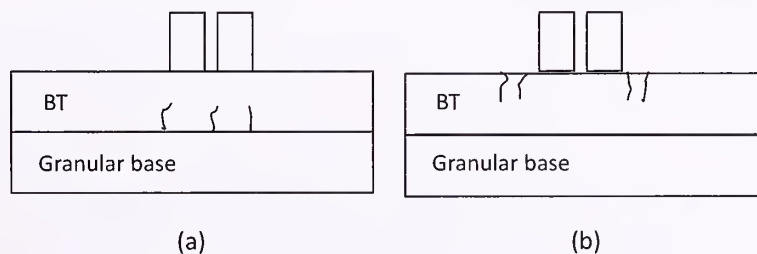
$$\epsilon_p/\epsilon_v = K \times (N)^c \quad \dots (I-1)$$

Where  $\epsilon_p$  and  $\epsilon_v$  are plastic and elastic strains respectively,  $N$  = number of repetition of axle loads,  $K$  and  $c$  are constants

If the computed  $\epsilon_v$  on the subgrade for a given wheel load is low, the vertical strain in the upper granular layers also is low. Hence limiting the subgrade strain controls the rutting in the subgrade as well as in the granular layers. Bituminous layer must have a rut resistant mix.

The elastic tensile strains,  $\epsilon_t$ , at the bottom and at the top of the bituminous layer should not exceed a certain limit for a given design traffic to control development of cracks during the design period. Surface crack may develop on either side of the wheel path as shown in **Fig. I-1**. Tensile strains near the edge of the tyres can be higher than that at the bottom and surface cracks may develop much earlier than those at the bottom particularly at higher temperatures. Though a number of cases of Top Down Cracking within a year or two of opening to traffic has been found at many locations (39, 53 and 63) in the BC and the DBM layers in India, surface bleeding and rutting (49, 51 and 61) rather than surface cracking has been very common because of secondary compaction owing to the softer bitumen for the climate and traffic.

Surface transverse surface cracks may also develop due to horizontal shear stresses applied by wheels of heavy commercial vehicles during acceleration and braking if the mix does not have sufficient tensile strength. The surface cracks responsible for top down cracking shown in **Fig. I-1** can be delayed by using high viscosity binder such as VG 40 or polymer/Crumb rubber modified binder because of higher tensile strength in the top layer of the bituminous surfacing at higher temperatures. Low temperature transverse cracking associated with stiffer binders is not a problem in plains of India. Bitumen of lower viscosity controls transverse surface cracking in colder regions as per international experience. In the light of the above, the approach discussed in the following is recommended for design of bituminous pavements.



**Fig. I-1 Cracks at Bottom (a) and Top (b)**

**I-2: Rutting in Subgrade and Granular Layer**

Large amount of field data for rutting in flexible pavements were collected and analyzed during several research projects of MORTH; and a relationship between limiting surface rutting of 20 mm and the vertical elastic subgrade strain was developed for different repetitions of standard axle loads and it was subsequently adopted in IRC:37-2001. The bituminous layers were not very thick in India in eighties and nineties when rutting data was collected and most of the rutting took place in the subgrade and the granular layers only. The equations for rutting for 80 per cent and 90 per cent reliability respectively are given (46, 54) as

$$N = 4.1656 \times 10^{-08} [1/\epsilon_v]^{4.5337} \quad \dots (I-2)$$

$$N = 1.41 \times 10^{-88} \times [1/\epsilon_v]^{4.5337} \quad \dots (I-3)$$

Equation I-2 was used as the rutting criterion in IRC:37-2001 for controlling rutting in the subgrade and granular layers, and the rutting in the bituminous layer was to be taken care of by selecting appropriate binder and mix design.

A more correct approach would be to estimate permanent deformation in different layers by spectrum of axle loads adopted in mechanistic-empirical pavement design method as recommended in MEPDG (3) but this would require massive coordinated research effort in the laboratory as well as in the field in different regions of the country so that laboratory equations can be calibrated and validated from field performance. Data from other countries can not directly be used due to different types of traffic and climate. Equation I-2 having a reliability of 80 per cent is based upon a good data base for limiting rutting in granular layers and the subgrade soils. Equation I-3 is recommended for 90 per cent reliability for high volume roads with traffic greater than 30 msa. Providing large thickness of granular layer does not cause any marked reduction in the thickness of bituminous layer from fatigue considerations. The thickness of the sub-base should be sufficient to stand the construction traffic and the granular base also should be thick enough so as not to cause the damage to GSB. These factors were considered in developing the design charts of IRC:37-2001. Field performance data of pavements designed as per IRC:37-2001 indicated unacceptable rutting in the bituminous layer rather than in the granular layer within a year or two of construction of highways (49, 51 and 61) because of use of softer bitumen for the climate, higher temperatures and heavy axle loads. This problem is now addressed by the selection of high viscosity binder for the bituminous mix in line with the European practice.

**I-3: Rutting in the Bituminous Layer**

Thickness of bituminous layers in India for flexible pavements with granular bases can be close to 200 mm or higher for heavy volume roads. The rutting in the bituminous layer is to be controlled by selecting a mix using binder of appropriate viscosity considering the traffic, climate and field experience. Rut resistant mixes for high volume traffic with air temperatures of 40°C and above can be obtained by using high viscosity binders. Laboratory rut tests using IITKGP RUT tester on mixes with VG 40 bitumen, and some modified binders indicated



almost equal performance at 50°C. VG 30 bitumen gave much higher rutting in the rut tester, a phenomenon observed in the field also though it meets the superpave specification requirement (5, 38) of 1 kPa for  $G^*/\sin \delta$  at 64°C using Dynamic Shear Rheometer. Analysis by MEPDG model (3) also predicted 50 per cent rut depth in mixes with VG 40 bitumen as compared to that with VG 30 (50). Even when modified bitumen is used in the wearing course, the rutting may occur in the DBM layer made with VG 30 just below the wearing course (51). Hence a higher grade of binder is recommended for the mix both for the BC and the DBM layer below the wearing course under heavy traffic conditions for the maximum air temperatures of 40°C and higher, very common on plains of India. Recommendation of IRC: 111-2009 (29) for use of VG 40 bitumen in BC as well as DBM layer may be adopted if the pavement carries over 2000 commercial vehicles per day. Stone Matrix Asphalt (IRC: SP: 79-2008) (32) is another wearing course that is known to be rut as well as fatigue resistant. Marshall Method of mix design is recommended for determination of optimum binder content.

#### **1.4: Fatigue Resistant Bituminous Layer**

Laboratory tests and field performance indicate (3, 20, 27, 38 and 40) that fatigue life of a bituminous layer depends to a great extent on the bitumen content for a given mix. A bituminous layer with higher modulus develops lower tensile strain by a wheel load at the bottom of the layer. To ensure that the bottom Dense Bituminous Macadam has a higher fatigue life, it should contain higher bitumen content. But softer grade bitumen such as VG 30 may give an unstable mix with higher bitumen content if exposed to construction traffic. For a bituminous layer thickness of 150 mm and higher, the temperature of the bottom DBM is lower than the top and there is little chance of rutting in the bottom layer if the air void is close to 3 per cent. Higher bitumen content in the bottom layer makes the mix resistant to stripping and it also provides a strong barrier for entry of moisture into the upper bituminous layer (20). Computations further shows that the tensile strain in the wearing course near the edge of the tyre can be even higher (3, 50 and 63) than that at the bottom of bituminous layer particularly at higher temperatures and therefore, the wearing course also must be fatigue resistant in addition to being rut resistant. Surface longitudinal cracking was also noticed during Heavy Vehicle Simulator testing at the Central Road Research Institute also. In a two layer bituminous construction consisting of BC and DBM, VG 40 should be used for both the layers with DBM having 0.5 per cent to 0.6 per cent higher bitumen content so that the air void after the compaction is close to 3 per cent. Mixes with Polymer and Crumb Rubber Modified binders have fatigue lives which can be two to ten times higher than the normal mixes (38, 44 and 69) depending upon the binder content and designers can utilize this property in designing high fatigue life bituminous pavements after carrying out laboratory tests both on normal and modified bituminous mixes for the evaluation of their relative fatigue lives.

#### **1.5: Fatigue Equations**

Fatigue lives of a bituminous mixture at a reliability level of 80 per cent and 90 per cent

(46, 54) respectively are given as

$$N_f = 2.21 * 10^{-04} \times [1/\epsilon_t]^{3.89} * [1/M_R]^{0.854} \quad \dots (I-4)$$

$$N_f = 0.711 * 10^{-04} \times [1/\epsilon_t]^{3.89} * [1/M_R]^{0.854} \quad \dots (I-5)$$

$N_f$  = fatigue life,  $\epsilon_t$  = Maximum Tensile strain at the bottom of the bituminous layer,  $M_R$  = resilient modulus of the bituminous layer.

Equation I-4 was used in IRC: 37-2001. Equation I-5 gives fatigue life which is about one third of that given by Equation I-4 for a given strain and modulus and the thickness of the bituminous layer would be much higher for a given traffic leading to very high cost. High volume highways demand a reliability level of 90 per cent and higher. This practice is followed in all international guidelines to avoid frequent maintenance. Mix design is the key factor to enhance the fatigue life without any marked increase in thickness.

### I-6: Mix Design and Fatigue Life

The bitumen content of the DBM mixes used in major highways in India varies generally from a minimum of 4 per cent to a maximum of about 5 per cent depending upon the gradation and the specific gravity of the aggregates; and the recommended air void content range is 3 to 6 per cent (62) with an average of air void content of about 4.5 per cent. In a two layer DBM, the fatigue life of bottom layer needs to be enhanced by increasing its bitumen content so that the cracks do not propagate from the bottom during the design life of the pavement. Though softer bitumen can be used in lower layers since the temperature may not be too high below 100 mm depth, use of such bitumen would require thicker DBM layer because of its lower modulus. Asphalt Institute (6), Shell (60) and MEPDG (3) have given equations for determination of fatigue life of bituminous mixtures for different values of volume of bitumen ( $V_b$ ) and the air voids ( $V_a$ ) and same basic approach was used to modify the calibrated fatigue equations to obtain high fatigue mixes. The fatigue Equation I-5 having a reliability level of 90 per cent is modified to include the mix design variables such as air void and volume of bitumen as given below,

$$N_f = 0.5161 * C * 10^{-04} \times [1/\epsilon_t]^{3.89} * [1/M_R]^{0.854} \quad \dots (I-6)$$

$$\text{Where, } C = 10^M, M = 4.84 \left( \frac{V_b}{V_a + V_b} - 0.69 \right) \quad \dots (I-7)$$

$V_a$  = per cent volume of air void and  $V_b$  = per cent volume of bitumen in a given volume of bituminous mix.

$N_f$  = fatigue life,  $\epsilon_t$  = maximum tensile strain at the bottom of DBM.

$M_R$  = Resilient modulus of bituminous mix.

If  $V_a = 4.5$  per cent and  $V_b = 11.5$  per cent (corresponding to bitumen content of approximately 4.5 per cent by weight of total mix), Equation I-6 is reduced to Equation I-5 If the constant 0.5161 of Equation I-6 is replaced by 1.604 (= 0.5161 x 2.21/0.711) the modified equation



considering the mix design variable  $V_a$  and  $V_b$  will have a reliability of 80 per cent. Effect of bitumen content can thus be considered to determine the fatigue life of a bituminous mixture in colder areas at 80 per cent reliability using VG 30 bitumen or softer bitumen depending upon the climate as recommended in IRC:111-2009.(29)

Equations I-4 and I-5 give fatigue lives for 20 per cent cracked area of the bituminous layer at a reliability level of 80 and 90 per cent respectively at the end of the design period. In other words, only 10 per cent of the area may have 20 per cent cracks if 90 per cent reliability is used for high volume highways. To avoid frequent maintenance, a reliability level of 90 per cent is recommended for highways having a design traffic exceeding 30 msa. Since most places on plains of India have maximum air temperatures equal to 40°C or higher, VG 40 bitumen is recommended for higher traffic and hardly any additional thickness of bituminous layer other than what is specified as per IRC:37-2001 will be required if the bottom bituminous layer is made fatigue resistant by increasing the binder content by 0.5 per cent to 0.6 per cent so that the air void is around 3 per cent. Mix design exercise is required to be done to get a durable mix. The thickness requirement is less when stiffer binder is used. Mix design and pavement design should be integrated to get an optimum design. Using the principle outlined above, a pavement can be designed so that the bottom rich bituminous layer has a very long fracture life and only the wearing course is subjected to distress such as surface cracks, rutting, raveling, pot holes etc. due to traffic and ageing and it would need replacement from time to time. On a close examination of Equations I-6 and I-7, it is found the Equation I-6 with a reliability level of 90 per cent reduces very close to Equation I-4 if air void of the bottom DBM layer is 3 per cent and volume of bitumen is about 13 per cent.

The modified fatigue equation having a 90 per cent reliability with air void around 3 per cent and the volume of bitumen of about 13 per cent is given as

$$N_f = 2.021 * 10^{-04} \times [1/\epsilon_t]^{3.89} * [1/M_R]^{0.854} \quad \dots (I-8)$$

Constants of Equations I.4 and I.8 are almost same and hardly any additional thickness of the bituminous layer is needed for a better performing pavement using Equation I-8. The constant 2.021 of Equation I-8 can be increased further by increasing volume of bitumen by opening the grading and even 2 per cent air void in deep bituminous layer has been recommended (27) for long life pavements.

**Fig. I-2** illustrates the effect of mix design variables on fatigue life. It can be seen that for a mix modulus of 3000 MPa, if  $V_a$  is decreased from 5 per cent, to 3 per cent and  $V_b$  is increased from 10 per cent to 13 per cent, the fatigue life at the tensile strain of 200E-04 increases from 1.00E + 07 to 5.00E + 07. Similarly, the fatigue life of the mix with a modulus of 1700 MPa increases from 1.7 E + 07 to 8.0E + 07 for identical change of mix variable. Mix design thus plays a very important role in design of bituminous pavements. It can also be seen that the fatigue life of the softer mix ( $M_R = 1700$  MPa) is higher than that of the stiffer mix ( $M_R = 3000$  MPa) but thickness also will be greater for the less stiff mix. Designers can develop better thickness combinations than what are given in different PLATES using innovative design



and life cycle cost be optimized considering the response of constructed pavements in different climate.

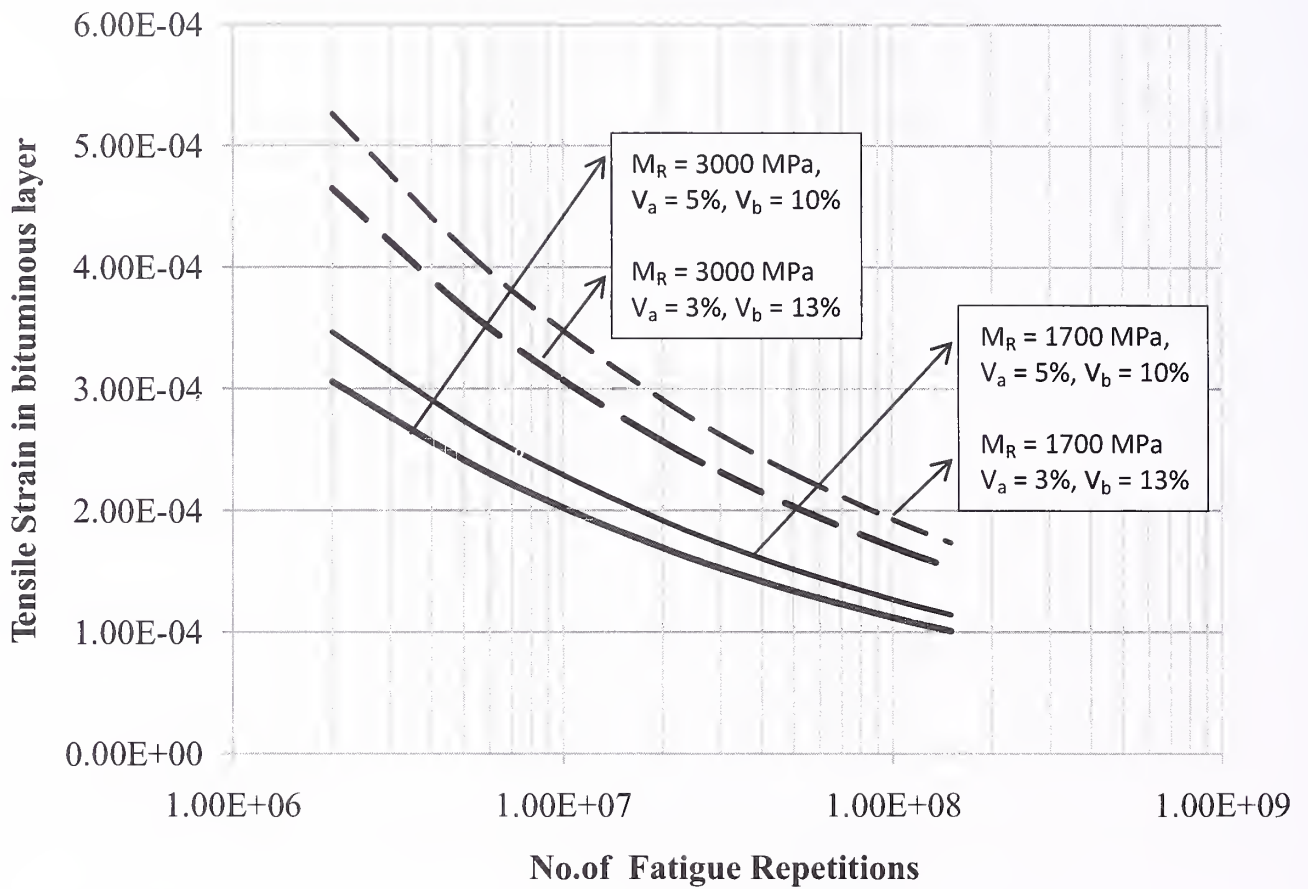


Fig. I-2 Effect of Air Void and Volume of Bitumen on Fatigue Life Bituminous Layer

**I-7: Flexural Fatigue of Thin Wearing Course**

When a thin wearing course of bituminous layer is provided over a granular layer, there is compressive bending strain due to a wheel load at the bottom of the bituminous layer which decreases with increasing thickness and becomes tensile with higher thickness as can be seen from Fig. I-3. Only when thickness reaches to about 50 mm, there is reduction in tensile strain with further increase in thickness of the bituminous layer.

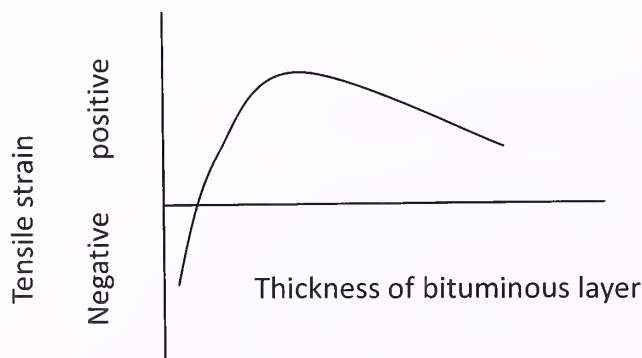


Fig. I-3 Tensile Strain in Thin Bituminous Wearing Course

**I-8: Resilient Modulus and Poisson's Ratio of Bituminous Mixes**

The Resilient modulus and Poisson's ratio values of bituminous mixes with different binders are given in Cl. 7.4. Typical values shown in **Table 7.1** were obtained by repeated bending test as per ASTM D7460-10 (13) under constant strain mode at 10 Hz frequency. The elastic modulus values for bituminous mixes were also obtained by Indirect Tensile strength test method as per ASTM D7369-09 (12) with a loading time of 0.1 seconds and a rest period of 0.9 seconds and modulus values were comparable. These moduli were used in calibration of fatigue equation.

**I-9: Temperature of Bituminous Surface for Pavement Design**

Fatigue behaviour and resilient modulus of a bituminous material depend upon its temperature and its variation within it. Hourly temperature data for consecutive three years were collected from Indian Meteorological Department for Mumbai, Guwahati, Hyderabad, New Delhi, Chennai and Kharagpur and Average Annual Air Temperatures were computed (54) respectively as 27.10°C, 23.87°C, 26.16°C, 24.53°C, 27.97°C and 28.16°C. A number of correlations have been developed relating Average Monthly Pavement Temperature (AMPT) and Average Monthly Air Temperature (AMAT) (69, 19) as well as Average Annual Pavement Temperature (AAPT) and Average Annual Air Temperature (AAAT) (18).

Equations given by Witczak and Brunton et al. are given as

$$\text{AMPT}(\text{°C}) = (1.05 \times \text{AMAT} (\text{°C})) + 5.0 \text{ (Witczak)} \quad \dots \text{ I-9}$$

$$\text{AMPT}(\text{°C}) = (1.15 \times \text{AMAT} (\text{°C})) + 3.17 \text{ (Brunton et al.)} \quad \dots \text{ I-10}$$

In the absence of any co-ordinated study in India, the AAAT values for different locations in India as mentioned above are substituted in Equations I-9 and I-10 and Average Annual Pavement Temperature comes to about 35°C recognizing that the above equations may not be strictly valid for Indian conditions. Hence resilient modulus of bituminous layer at 35°C has been considered in the guidelines for pavement analysis. This needs updation through a well coordinated pavement performance study in India. High summer temperatures dictate selection of binder for the upper layers. Similar approach can be adopted for temperature of the bituminous layer for pavement design in regions such as Himachal Pradesh, Uttarakhand, Jammu and Kashmir and Arunachal Pradesh.

**I-10: Design Charts**

Based on the fatigue and rutting equations, bituminous pavements can be designed for different subgrade modulus (CBR values). Design is to be optimized considering different options such as availability of aggregates, use of foamed bitumen/bitumen emulsion modified reclaimed asphalt pavements, foamed bitumen/bitumen emulsion modified fresh aggregates, cementitious base and cementitious sub-base. Reclaimed Asphalt Pavements (RAP) contains best quality aggregates and their use in GSB amounts to its under-utilization. The top 40 mm to 50 mm of the bituminous layer would suffer damage due to traffic and weathering and it

would require renewal from time to time. Hot recycling can be an alternative to conserve the materials. Since every region is unique from the consideration of traffic, cost and availability of materials, engineers have to develop pavement design to suit the region since the IRC-37 guidelines do not constitute a rigid standard, and sound engineering judgment based on local environment and pavement performance in the region is needed in developing a good design. In case of heavy rainfall area, proper internal drainage also should be provided to increase the pavement life. Local experience should be made use of while selecting the pavement layers. A few examples of pavement designs are illustrated for different subgrade modulus values corresponding to CBR of 3 per cent to 15 per cent and design traffic ranging from 2 msa to 150 msa. Examples are also given for (a) a pavement having a design life of 300 msa and (b) a perpetual pavement in the light of international experience. For design traffic less than 2 msa, IRC:SP:72-2007 (35) would be applicable. City streets should be designed for the minimum design traffic of 2 msa because of frequent heavily loaded construction traffic. Beyond the subgrade CBR of 10 per cent, pavement thickness is affected only marginally. Temperature effect is taken care of by assigning appropriate value of resilient modulus to the bituminous layer depending upon the AAPT. 35°C is the most appropriate AAPT for plains of India (54).



**ANNEX-II**

(Clause 9.1)

**Worked-out Examples Illustrating the Design Method****(i) Bituminous Pavements with Untreated Granular Layer**

**Example-I:** Design the pavement for construction of a new flexible pavement with the following data:

**DATA**

- (i) Four lane divided carriageway
- (ii) Initial traffic in the year of completion of construction = 5000 CV/day  
(Sum of both directions)
- (iii) Percentage of Single, Tandem and Tridem axles are 45 per cent, 45 per cent and 10 per cent respectively
- (iv) Traffic growth rate per annum = 6.0 per cent
- (v) Design life = 20 years
- (vi) Vehicle damage factor = 5.2  
(Based on axle load survey)
- (vii) CBR of soil below the 500 mm of the subgrade = 3 per cent
- (viii) CBR of the 500 mm of the subgrade from borrow pits = 10 per cent

**DESIGN CALCULATIONS**

- (i) Lane Distribution factor = 0.75
- (ii) Initial traffic = 2500 CVPD assuming 50 per cent in each direction.
- (iii) Vehicle Damage Factor (VDF) computed for the traffic = 5.2.
- (iv) Cumulative number of standard axles to be catered for in the design
 
$$N = \frac{2500 \times 365 \times [(1 + 0.06)^{20} - 1]}{0.06} \times 0.75 \times 5.2 = 131 \text{ msa}$$
- (v) CBR of the embankment material = 3 per cent, CBR of 500 mm of subgrade = 10 per cent,  
Effective CBR of the subgrade from Fig. 5.1 = 7 per cent  
Design resilient modulus of the compacted subgrade =  $17.6(7)^{0.64} = 62 \text{ MPa}$
- (vi) Thickness of granular layers: WMM = 250 mm, GSB = 230 mm  
Resilient modulus of granular layer =  $0.2 \times (480)^{0.45} \times 62 = 200 \text{ MPa}$ .

Thickness of proposed Bituminous layer with VG 40 bitumen with bottom DBM layer having air void of 3 per cent (0.5 per cent to 0.6 per cent additional bitumen over OBC) over WMM and GSB = 185 mm at reliability of 90 per cent.

(The thickness of the bituminous layer as per IRC: 37-2001 = 210 mm at reliability of 80 per cent).

**(ii) Bituminous Pavement with Cemented Base and Cemented Sub-base with Aggregate Interlayer of 100 mm**

Design traffic as above 131 msa.

Bituminous layer with VG 40 (BC + DBM) = 100 mm.

Aggregate interlayer = 100 mm.

Cemented base = 120 mm ((thickness of the cemented base for CBR 5 and 10 are 130 mm and 100 mm respectively).

Cemented sub-base layer for drainage and separation = 250 mm.

The upper 100 mm of the cemented sub-base should be open graded so that its permeability is about 300 mm/day or higher for quick removal of water entering from the surface.

Checking of the safety of cemented base due to spectrum of axle loads resulting in msa of 131.

Since there are plenty of single, tandem and tridem axle loads which are far higher than standard axle load used for pavement design, thickness of cement layer must be checked for sudden fracture of the brittle material like cemented base due to higher axle loads using cumulative damage principle. One tandem axle is taken as two single axles and one tridem axle is taken as three axles carrying equal weight since the interference of stresses at the cemented base are little due to axle loads being about 1.30 m to 1.40 m apart. All multiple axle vehicles are combination of single, tandem and tridem axles. The axle load data can be classified or grouped in such a manner that all tandem and tridem axles can be converted into single axle repetition for stress analysis The axle load spectrum of the traffic data is as follows.

Single Axle Loads		Tandem Axle Loads		Tridem Axle Loads	
Axle Load Class (kN)	Percentage of Axles	Axle Load Class (kN)	Percentage of Axles	Axle Load Class (kN)	Percentage of Axles
185-195	0.64	390-410	1.85	585-615	1.4
175-185	0.8	370-390	2.03	555-585	1.6
165-175	0.8	350-370	2.03	525-555	1.60
155-165	2.58	330-350	2.08	495-525	1.80
145-155	2.58	310-330	2.08	465-495	1.80
135-145	5.8	290-310	4.17	435-465	4.4
125-135	5.8	270-290	4.17	405-435	4.4

Single Axle Loads		Tandem Axle Loads		Tridem Axle Loads	
Axle Load Class (kN)	Percentage of Axles	Axle Load Class (kN)	Percentage of Axles	Axle Load Class (kN)	Percentage of Axles
115-125	11.82	250-270	12.67	375-405	13.10
105-115	11.82	230-250	12.67	345-375	13.10
95-105	12.9	210-230	10.45	315-345	10.90
85-95	12.16	190-210	10.45	285-315	10.4
<85	32.3	170-190	7.05	255-285	7.15
		<170	28.28	<255	28.33
<b>Total</b>	<b>100</b>	<b>Total</b>	<b>100</b>	<b>Total</b>	<b>100</b>

Cumulative fatigue damage analysis is computed as follows for Single, Tandem and Tridem Axle respectively considering flexural strength of cemented base as 1.4 MPa.

#### Cumulative fatigue damage analysis for Single Axle

Modulus of Rupture of the cementitious base = 1.4 MPa

Axle Load in kN	Expected Repetitions	Stress in MPa	Stress Ratio	Fatigue Life	Fatigue life Consumed
190	72504	0.70	0.50	5.37E + 05	0.14
180	90631	0.66	0.47	1.12E + 06	0.08
170	90631	0.63	0.45	2.33E + 06	0.04
160	292283	0.59	0.42	4.85E + 06	0.06
150	292283	0.55	0.39	1.01E + 07	0.03
140	657071	0.52	0.37	2.10E + 07	0.03
130	657071	0.48	0.34	4.38E + 07	0.02
120	1339066	0.44	0.32	9.11E + 07	0.01
110	1339066	0.40	0.29	1.90E + 08	0.01
100	1461417	0.37	0.26	3.95E + 08	0.00
90	1377584	0.33	0.24	8.22E + 08	0.00
85	3659206	0.31	0.22	1.19E + 09	0.00
		cumm. Damage			<b>0.42</b>



**Cumulative fatigue damage analysis for Tandem Axle****Modulus of Rupture of the cementitious base = 1.4 MPa**

<b>Axle Load in kN</b>	<b>Expected Repetitions</b>	<b>Stress in MPa</b>	<b>Stress Ratio</b>	<b>Fatigue Life</b>	<b>Fatigue Life Consumed</b>
400	419166	0.74	0.53	2.58E + 05	1.626
380	459950	0.70	0.50	5.37E + 05	0.857
360	459950	0.66	0.47	1.12E + 06	0.411
340	471279	0.63	0.45	2.33E + 06	0.202
320	471279	0.59	0.42	4.85E + 06	0.097
300	944823	0.55	0.39	1.01E + 07	0.094
280	944823	0.52	0.37	2.10E + 07	0.045
260	2870721	0.48	0.34	4.38E + 07	0.066
240	2870721	0.44	0.32	9.11E + 07	0.032
220	2367722	0.40	0.29	1.90E + 08	0.012
200	2367722	0.37	0.26	3.95E + 08	0.006
180	1597363	0.33	0.24	8.22E + 08	0.002
170	6407576	0.31	0.22	1.19E + 09	0.005
		cumm. Damage			<b>3.46</b>

**Cumulative fatigue damage analysis for Tridem Axle****Modulus of Rupture of the cementitious base = 1.4 MPa**

<b>Axle Load in kN</b>	<b>Expected Repetitions</b>	<b>Stress in MPa</b>	<b>Stress Ratio</b>	<b>Fatigue Life</b>	<b>Fatigue Life Consumed</b>
600	105736	0.74	0.53	2.58E+05	0.410
570	120841	0.70	0.50	5.37E+05	0.225
540	120841	0.66	0.47	1.12E+06	0.108
510	135946	0.63	0.45	2.33E+06	0.058
480	135946	0.59	0.42	4.85E+06	0.028

Axle Load in kN	Expected Repetitions	Stress in MPa	Stress Ratio	Fatigue Life	Fatigue Life Consumed
450	332312	0.55	0.39	1.01E+07	0.033
420	332312	0.52	0.37	2.10E+07	0.016
390	989383	0.48	0.34	4.38E+07	0.023
360	989383	0.44	0.32	9.11E+07	0.011
330	823227	0.40	0.29	1.90E+08	0.004
300	785464	0.37	0.26	3.95E+08	0.002
270	540007	0.33	0.24	8.22E+08	0.001
255	2139635	0.31	0.22	1.19E+09	0.002
		cumm. Damage			<b>0.92</b>

It can be seen that total fatigue damage is greater than 1. Hence the pavement is unsafe and cemented layer will crack prematurely. It can also be noticed that the Tandem axle weighing 400 kN causes maximum fatigue damage followed by Tandem axle of 380 kN. It can also be seen that stress variation is linear due to linear stress analysis. If the load is halved, stress also is halved.

If the heavy axle loads are not allowed, the pavement would be safe. If the cemented layer thickness is increased from 120 mm to 160 mm Cumulative Fatigue Damage (CFD) is computed as 0.92 and for 165 mm CFD is 0.89 cumulative fatigue damage is and hence the pavement is safe. If the modulus of rupture is 1.20 MPa, a thickness of 220 mm is needed. Such checks are to be made on cemented layer because of heavy loading over the highways in India.

**(iii) Bituminous Pavement with Cemented Base and Cemented Sub-base with SAMI Layer Over Cemented Base**

Design traffic = 131 msa.

Bituminous layer with VG 40 (BC + DBM) = 100 mm.

Cemented base = 165 mm estimated from the plates 14 and 15 for cumulative fatigue damage analysis

Cemented sub-base layer for drainage and separation = 250 mm.

Checks must be done for cumulative fatigue damage as explained in the previous example.

The upper 100 mm of the cemented sub-base should be open graded so that its permeability is about 300 mm/day or higher for quick removal of water entering from the surface in high rainfall area.

**(iv) Bituminous Pavement with Base of Fresh Aggregates or Reclaimed Asphalt Pavement (RAP) Treated with Foamed Bitumen/Bitumen Emulsion and Cemented Sub-Base**

Design traffic = 131 msa

Bituminous layer with VG 40 (BC + DBM) = 100 mm.

Treated aggregates RAP = 180 mm estimated from plates 18 and 19 and design is found to be safe from strain consideration.

Cemented sub-base layer for drainage and separation = 250 mm.

**(v) Bituminous Pavement with Cemented Base and Granular Sub-base with 100 mm WMM Layer Over Cemented Base**

Design traffic = 131 msa

BC (VG 40) = 50 mm, DBM (VG 40) = 50 mm, WMM = 100 mm, cemented base = 195 mm estimated from plates 22 and 23 for fatigue damage analysis, GSB = 250 mm.

The upper 100 mm of the cemented/granular sub-base should be open graded so that its permeability is about 300 mm/day or higher for quick removal of water entering from the surface.

**Design of Flexible Pavement for 300 msa of Traffic**

Many highways have heavy volume of traffic and the design traffic at the end of concession period can be as high as 300 msa. If the pavement design and mix design are integrated, only the top wearing course of 40 mm to 50 mm suffer damaged by the traffic and ageing. Low life cycle cost may justify use of thicker bituminous layer in which only the top 40 mm to 50 mm is milled and replaced with a fresh bituminous wearing course or a hot in-situ recycled mix to remove the cracked and deformed spots and restore the riding quality. The design has to be done for 90 per cent reliability to eliminate frequent interruption for repair.

Assumed Design Parameters

Resilient modulus of subgrade = 75 MPa (corresponding to Effective subgrade CBR of 10 per cent).

Thickness of Granular Sub-base = 350 mm for separation and drainage



Lower 200 mm of GSB is close graded (MORTH) to act as separation layer and the top 150 mm GSB is an open graded granular material treated with 1.5 to 2 per cent bitumen emulsion to have a permeability of 300 m/day or higher to act as a drainage layer. Its Los Angeles abrasion value must be less than 40 to avoid crushing during rolling.

Bituminous layer must be bottom rich, that is, the bottom layer should have an air-void of 3 per cent after the compaction by traffic. This is achieved by having additional bitumen of 0.5 to 0.6 per cent higher than the optimum bitumen content. This can be established from the laboratory tests and a field trial. The bitumen should be of grade VG 40 for the plains in India to control rutting, where temperatures are much higher. In case of non-availability of VG 40 bitumen, PMB/CRMB has to be used to obtain rut resistant mixes.

Resilient Modulus of Bituminous layer = 3000 MPa (As per IRC: 37)

**Thickness of the Pavement is Worked out as:**

Thickness of the bituminous layer = 225 mm.

Thickness of Granular Sub-base = 350 mm.

**Strains in different layers for a design traffic of 300 msa,**

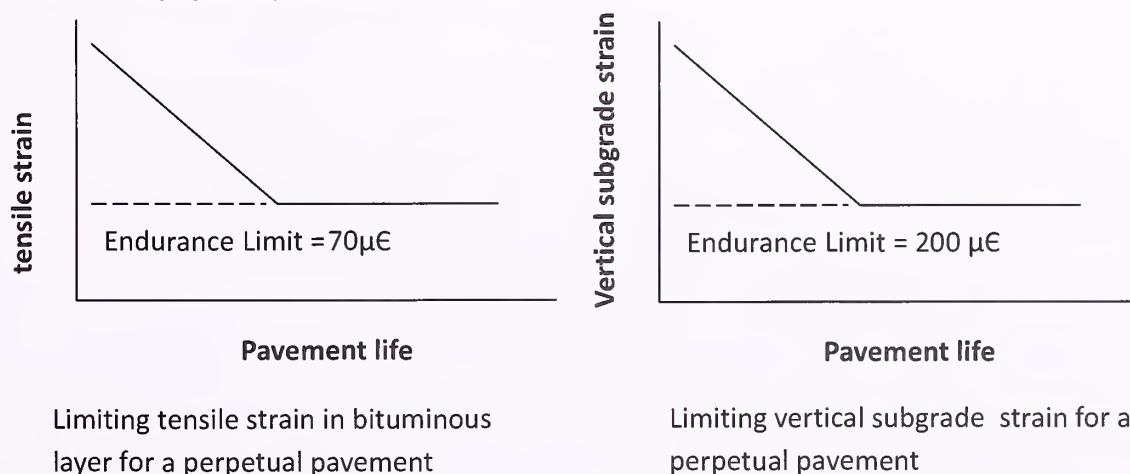
Allowable tensile strain in the bitumen rich bottom bituminous layer = 131  $\mu\epsilon$

(Computed maximum tensile strain = 125  $\mu\epsilon$ ).

Allowable vertical subgrade strain = 250  $\mu\epsilon$ . (Computed maximum vertical subgrade strain = 239  $\mu\epsilon$ ).

### Perpetual Pavements

The pavements which have a life of 50 years or longer are termed as perpetual pavements. If the tensile strain caused by the traffic in the bituminous layer is less than 70 micro strains, the endurance limit of the material, the bituminous layer never cracks (Asphalt Institute, MS-4, 7<sup>th</sup> edition 2007). Similarly if vertical subgrade strain is less than 200 micro strain, rutting in subgrade will be negligible (**Fig. II-1**). Design of such a pavement is illustrated in the guideline.



**Fig. II-1 Limiting Design Strain for a Perpetual Pavement**

IRC:37-2012

### **Design Example of Perpetual Pavement**

Allowable subgrade strain = 200  $\mu\epsilon$ .

Allowable tensile strain in the bituminous layer = 70  $\mu\epsilon$ .

Modulus of the Bituminous layer = 3000 MPa (VG 40 Bitumen).

Elastic Modulus of subgrade = 60 MPa (corresponding to CBR of 7 per cent).

Granular Drainage and Separation layer = 200 mm.

Modulus of drainage layer = 130 MPa.

Thickness of the Bituminous layer to meet the above requirement = 380 mm.

The computed strain in the bituminous layer is 68  $\mu\epsilon$  and the vertical subgrade strain is obtained as 168  $\mu\epsilon$ . (The analysis is done by IITPAVE software).

## ANNEX-III

### Equivalence of Thickness of Bituminous Mixes of Different Moduli

Two elastic layers are approximately of equal flexural stiffness if their moduli, poisson's ratios and thickness are related as

$$E_1 H_1^3 / 12(1 - \mu_1^2) = E_2 H_2^3 / 12(1 - \mu_2^2) \quad \dots \text{III-1}$$

Where,

$E_1$ ,  $H_1$ ,  $\mu_1$ , and  $E_2$ ,  $H_2$ ,  $\mu_2$  are the Elastic Modulus, Thickness and Poisson's Ratio of the two mixes. Different layers can be combined into less number of layers for computation if necessary.

Example Convert 180 mm of DBM with VG 30 into that with VG 40

180 mm DBM with VG 30

$$180 \times (1700/3000)^{0.333} = 150 \text{ mm DBM with VG 40 bitumen}$$

Though bending behaviour may be comparable, rutting in the bituminous layer will be reduced with stiffer bitumen. Analysis indicates that rutting of mixes with VG 40 bitumen is half of that with VG 30 bitumen.



**ANNEX-IV**

(Refer Clause 5.1.1.2)

**Preparation of Laboratory Test Specimens for CBR Test and Selection of Subgrade CBR for Pavement Design****Sample Preparation**

- (1) Wherever possible, the test specimens should be prepared by static compaction, but if not possible, dynamic method may be used as an alternative.

**Static Compaction**

- (2) The weight of wet soil at the required moisture content to give the intended density when occupying the standard test mould is calculated as follows:

$$\text{Volume of mould} = 2209 \text{ cc}$$

$$\text{Weight of dry soil} = 2209 d \text{ gm}$$

$$\text{Weight of the Wet Soil} = \frac{(100 + m)}{100} \times 2209 d \text{ gm}$$

Where,

$d$  = Required dry density in gm/cc

$m$  = Required moisture content in per cent.

- (3) The soil lumps are broken down and stones larger than 20 mm are removed. Sufficient quantity of the soil is mixed with water to give the required moisture content. The correct weight of wet soil is placed in the mould. After initial tamping with a steel rod, a filter paper is placed on top of the soil, followed by the 50 mm displacer disc, and the specimen compressed in the compression machine until the top of the displacer is flush with the top of the collar. The load is held for about 30 seconds and then released. In some soil types where a certain amount of rebound occurs, it may be necessary to reapply load to force the displacer disc slightly below the top of the mould so that on rebound the right volume is obtained.

**Dynamic Compaction**

- (4) The soil is mixed with water to give the required moisture content, and then compacted into the mould in three layers using a standard soil rammer. After compaction, the soil is trimmed flush with the top of the mould with the help of a metal straight edge. The mould is weighed full and empty to enable determination of wet bulk density, and from it, knowing the moisture content, the dry density is calculated.
- (5) Further specimens, at the same moisture content, are then prepared to different dry densities by varying the number of blows applied to each layer of soil so that the amount of compaction that will fill the mould uniformly with calculated weight of wet soil (vide para 2 above) is known.

## Selection of Subgrade CBR for Pavement Design

The CBR values of the subgrade soil varies along a highway alignment even on a homogeneous section. 90<sup>th</sup> percentile CBR is recommended in the guidelines. Method of determination of the 90<sup>th</sup> percentile is given below. The following example illustrates the procedure for finding the design.

16 CBR values for a highway alignment are as follows:

3.5, 5.2, 8.0, 6.8, 8.8, 4.2, 6.4, 4.6, 9.0, 5.7, 8.4, 8.2, 7.3, 8.6, 8.9, 7.6

Arrange the above 16 values in ascending order

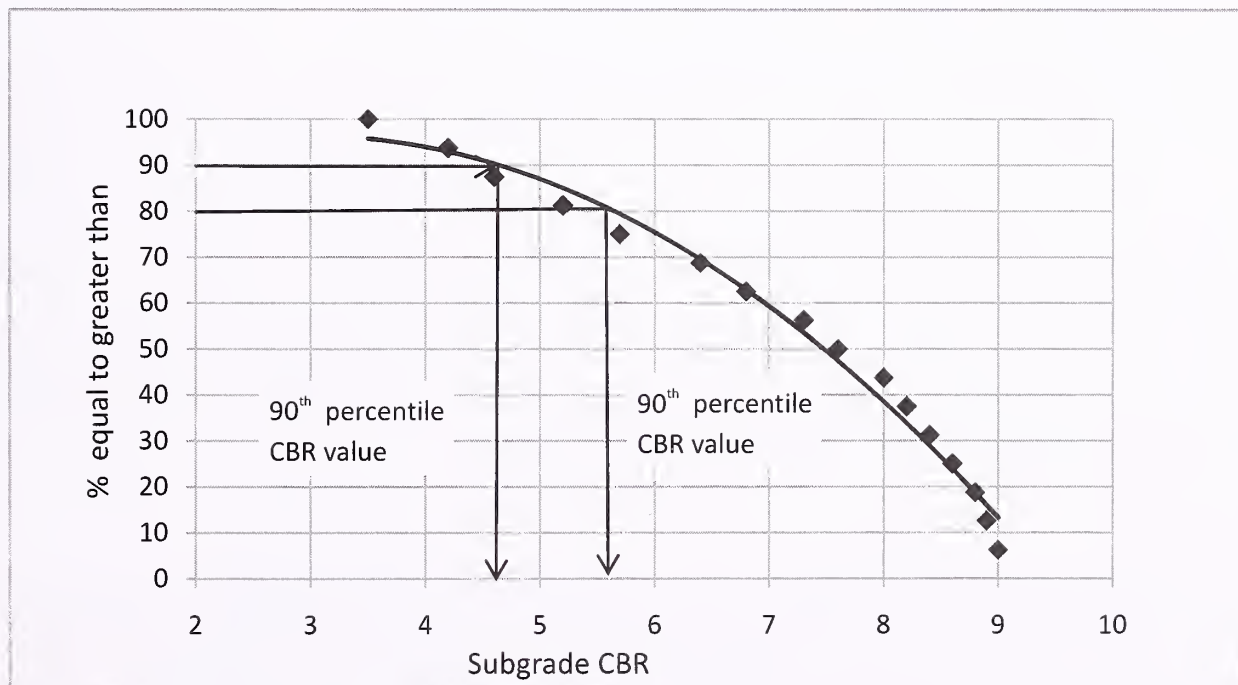
3.5, 4.2, 4.6, 5.2, 5.7, 6.4, 6.8, 7.3, 7.6, 8.0, 8.2, 8.4, 8.6, 8.8, 8.9, 9.0

Now calculate the percentage greater than equal to each of the values as follows:

For CBR of 3.5, percentage of values greater than equal to 3.5 =  $(16/16) * 100 = 100$

For CBR of 4.2, percentage of values greater than equal to 4.2 =  $(15/16) * 100 = 93.75$  and so on.

Now a plot is made between percentages of values greater than equal and the CBR values versus the CBR as follows.



**Fig. IV.1 Evaluation of Subgrade CBR for Pavement Design**

The 90<sup>th</sup> percentile CBR value = 4.7, and 80<sup>th</sup> percentile CBR = 5.7 in. Asphalt Institute of USA (6) recommends 87.5 percentile subgrade modulus for design traffic greater than one msa.

**NOTE:** If the data is very large, the CBR values can be grouped for homogenous sections and the same procedure followed.

### **Special Points Relating to Design of Pavement on Expansive Soils**

Potentially expansive soils, such as, black cotton soils are montmorillonite clays and are characterised by their extreme hardness and deep cracks when dry and with tendency for heaving during the process of wetting. Roadbeds made up of such soils when subjected to changes in moisture content due to seasonal wetting and drying or due to any other reason undergo volumetric changes leading to pavement distortion, cracking and general unevenness. In semi-arid climatic conditions, pronounced short wet and long dry conditions occur, which aggravate the problem of swelling and shrinkage. Due recognition of these problems at the design stage itself is required so that counter measures could be devised and incorporated in the pavement structure. A proper design incorporating the following measures may considerably minimise the problems associated with expansive soils.

The amount of volume change that occurs when an expansive soil road bed is exposed to additional moisture depends on the following:

- (a) The dry density of the compacted soil.
- (b) The moisture content.
- (c) Structure of soil and method of compaction.

Expansive soils swell very little when compacted at low densities and high moisture but swell greatly when compacted at high densities and low moisture. Hence, where the probability of moisture variation in the subgrade is high, it is expedient to compact the soil slightly wet of the field optimum moisture content (+2 per cent) determined on the basis of a field trial. Experience shows that generally, it is not practicable to compact expansive soils at OMC determined by Laboratory Proctor Test. It is, therefore, necessary to study its field moisture density relationship through compacting the soil at different moisture contents and under the same number of roller passes. A minimum density corresponding to 95 per cent of the standard proctor density should be attained in the field and recommended moisture content should be 1-2 per cent wet of optimum moisture content.

### **Buffer Layer**

There is a definite gain in placing the pavement on a non-expansive impermeable soil cushion of 0.6-1.0 m thickness. It prevents ingress of water in the underlying expansive soil layer, counteracts swelling and secondly even if the underlying expansive soil heaves, the movement will be more uniform and consequently more tolerable. However, where provision of non-expansive buffer layer is not economically feasible, a blanket course of suitable impermeable material and thickness as discussed below must be provided.



**Blanket Course**

An impermeable blanket course of at least 225 mm thickness and composed of coarse/medium sand or non-plastic moorum having PI less than five should be provided on the expansive soil subgrade as a sub-base to serve as an effective intrusion barrier. It must have very low permeability. The blanket course should extend over the entire formation width.

Alternatively, lime-stabilised black cotton sub-base extending over the entire formation width may be provided together with measures for efficient drainage of the pavement section.

## ANNEX-V

(Refer Clause 11.3)

### Drainage Layer

Improvement of drainage can significantly reduce the magnitude of seasonal heave. Special attention should, therefore, be given to provision of good drainage measures. The desirable requirements are:

- (a) Provision must be made for the lateral drainage of the pavement structural section. The granular sub-base/base should accordingly be extended across the shoulders
- (b) No standing water should be allowed on either side of the road embankment.
- (c) A minimum height of 1 m (or 0.6 m in case of existing road having no history of being overtopped) between the subgrade level and the highest water level should be ensured.

### Example of Design of a Drainage Layer

Design a granular drainage layer for a four lane heavy duty divided highway for an annual precipitation of 1200 mm. Longitudinal slope = 3 per cent, Camber = 2.5 per cent.

#### Crack Infiltration Method

Water travels along AD (**Fig. V-1**) due to camber and the longitudinal slope

Depth of drainage layer = 450 mm (Assuming BT = 200 mm and WMM = 250 mm)

Width of the drainage layer (one side of the median only)

= 8.5 m + 1.0 m + 2 x 0.45 = 10.4 m with 1.0 m wide unpaved shoulder

Fig. V-1, AB = 10.4 m, AC = 10.4 x 0.03/0.025 = 12.48 m.

$$AD = (10.4^2 + 12.48^2)^{0.5} = 16.24 \text{ m}$$

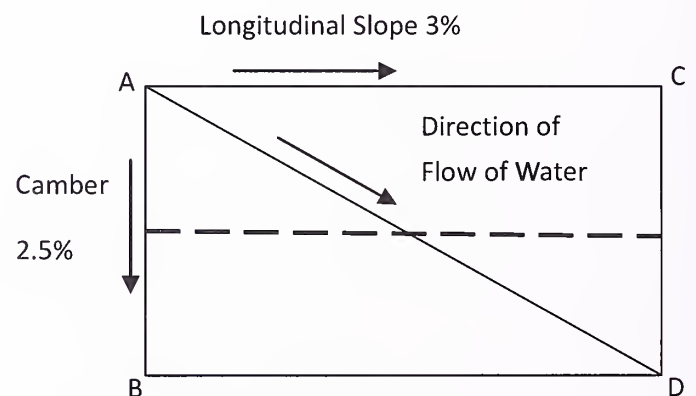
$$\text{Elevation drop along AC} = 12.48 \times 0.03 = 0.374 \text{ m}$$

$$\text{Elevation drop along CD} = 10.4 \times 0.025 = 0.26 \text{ m}$$

$$\text{Total drop along AD} = 0.634 \text{ m}$$

$$\text{Hydraulic gradient} = (\text{Elevation drop})/\text{length} = I = 0.634/16.24 = 0.039$$

$$q_i = I_c [N_c/W_p + W_c/(W_p C_s)]$$



**Fig. V-1 Direction of Flow of Water**

$I_c = 0.223 \text{ m}^3/\text{day}/\text{m}$ ,  $N_c$  (centre line and two edges) = 3,  $W_p$  (paved width + shoulder) = 10.4 m,  $W_c$  (crack width) =  $W_p$ ,  $C_s$  (assumed intervals of transverse cracks) = 12 m for flexible pavement

$$q_i = 0.083 \text{ m}^3/\text{day}/\text{m}^2.$$

Amount of water infiltration in pavement per metre width along the flow path AD

$$= 0.083 \times 1 \times 16.24 = 1.35 \text{ m}^3/\text{day} = Q$$

$$\text{Gradient} = 0.039$$

$Q = KAI$ ,  $KA = 1.35/0.039 = 34.62$ , where  $A$  = Area of Cross Section = Thickness of drainage Layer, m x 1.0 m,  $K$  = coefficient of Permeability, m/day,

If depth of drainage layer is 100 mm

$A = 1 \times 0.1 = 0.1 \text{ m}^2$ ,  $K = 34.62/0.1 = 346.62 \text{ m/day}$  If the thickness of drainage layer is doubled, the permeability requirement is half.

For major highways in which thick bituminous layer are provided, very little water can enter in the initial period of four to five years due to absence of cracking. Rain water may however enter through the pervious median if not designed properly. The AASHTO 93 gradation of the drainage layer is given below for guidance.

**Table V-1 Permeability of Untreated Graded Aggregates as per AASHTO (1993)**

Per cent Passing Sieve Opening, mm	Grading 1	Grading 2	Grading 3	Grading 4	Grading 5	Grading 6
20	100	100	100	100	100	100
12.5	85	84	83	81.5	79.5	75
9.5	77.5	76	74	72.5	69.5	63
4.76	58.3	56	52.5	49	43.5	32
2.36	42.5	39	34	29.5	22	5.8
2.00	39	35	30	25	17	0
0.84	26.5	22	15.5	9.8	0	0
0.42	18.2	13.3	6.3	0	0	0
0.25	13.0	7.5	0	0	0	0
0.105	6.0	0	0	0	0	0
0.075	0	0	0	0	0	0
Coeff. of permeability m/day	3	35	100	350	850	950



## ANNEX-VI

(Refer Clause 5.3)

### Recommendation for Bituminous Wearing Courses for Flexible Pavements

**VI-1:** India is a large country with vastly different climate in different areas and regional agencies have developed specifications suited to the local conditions. In wet climate, the wearing course has to be impermeable to prevent entry of water to lower layers.

**VI-2:** It is the long duration low intensity rainfall that damages the road rather than a low duration heavy downpour which drains away fast. High annual rainfall is not always the indicator of the wet weather damage though extensive damage may occur by water ponding. Even areas having rainfall less than 1000 mm suffer extensive damage during the rain when the bituminous surface is porous, and surface and sub-surface drainage does not drain away the water fast.

**VI-3:** Pavements with granular bases and sub-bases having a design traffic of 5 msa or higher have a minimum thickness of 50 mm of DBM with a good quality wearing course of SDBC or BC. Properly designed mixes of DBM and SDBC/BC having an air void content of about 4 per cent after the compaction by traffic are practically impermeable. They are expected to prevent entry of water into the lower layers even in high rainfall area if shoulders are protected and lateral entry of water from high ground is prevented. All care is to be taken to see that ravelling is avoided by ensuring good bond between aggregates and bitumen by using lime or anti-stripping compound particularly in wet area.

**VI-4:** The wearing course of premix carpet and seal coat has given mixed performance in built-up area because of poor drainage while it has performed reasonably well on well drained roads in rural area having a rainfall around 1500 mm. Applying seal coat is a manual operation and has to be done very carefully for proper sealing. Mixed Seal surfacing is the preferred alternative by most field engineers in Eastern India having a heavier rainfall because of better sealing property.

**VI-5:** Roads in high rainfall area are expected to have adequate provision for subsurface drainage as laid down in the guidelines so that the bituminous wearing course is not damaged due to stored water in the lower layers.

**VI-6:** Thickness charts in the guidelines with BC and SDBC wearing courses are valid for all rainfall area

**VI-7:** Two coat surface dressing has been used with success in South Africa (22) with traffic up to 5 msa even in wet region. The bitumen film in surface dressing is thick and makes the pavement completely impervious to ingress of water. Thick film does not undergo fatigue cracking also. In wet area such as North-East where clear days are fewer, bitumen emulsion can be used since the aggregates need not be dry and even windy conditions will help in evaporation of water from the emulsion and necessary bond is created among the aggregates used in the surface dressing.

**VI-8:** Bituminous wearing course laid over Water Bound Macadam (WBM) has performed very well in South Africa. WBM bases consist of a coarse single-sized aggregates together with fines added during the construction to fill the voids. Such bases are recommended by South Africa (66) for pavements carrying heavy traffic under wet weather condition. Tests in South Africa by Heavy Vehicle Simulator (48) found that WBM resists deformation better than the crushed stone base courses even under wet condition because of good interlocking of larger aggregate size of WBM. The work is labour intensive, but it can be one of the options in areas where there is serious problem with construction equipment.

## ANNEX-VII

(Refer Clause 7.4.2)

### Selection of Grade of Binders and Mixes for Bituminous Courses

**VII-1:** IRC: 111-2009 (29) recommends VG-40 bitumen if commercial vehicle exceeds 2000 per lane per day. Mix design, selection of grade of bitumen, gradation of aggregates and traffic loading are interrelated as explained in the guidelines. Local experience is the best guide.

**VII-2:** The British practice (23) is to use high modulus bases having bitumen of 50 penetration which allows 10-15 per cent reduction in thickness for equivalent performance or an extended life for the same thickness. It is to be noted that the summer temperatures are much lower in UK and other European countries where harder grade of bitumen (15, 25, 35 penetration) also is used in bases for very heavily trafficked highways. The filler content in DBM in UK (grading is same as that of IRC: 111-2009) (29) is increased from 2-9 per cent to 7-11 per cent in high modulus mixes and the resulting high modulus mix is designated as Heavy-duty Macadam (HDM). Higher filler content stiffens the HDM mix increasing its load spreading capacity.

**VII-3:** SUPERPAVE Mix design recommends binder which is one grade higher than required from temperature consideration for heavy traffic. For signalized intersection, two grades higher binder is recommended. If the most suitable binder is VG 30 for 450 to 1500 CVPD, VG 40 should be selected for higher volume of commercial vehicles. For areas on intersection and traffic signals, mixes like SMA and those with VG 40/polymer or crumb rubber modified bitumen would be suitable.

**VII-4:** Research Scheme R-55 of MORTH (55), Use of Rubber and Polymer Modified Bitumen in Bituminous Road Construction) by Central Road Research Institute indicates that wearing course of polymer and rubber modified bituminous mixes have longer lives and the intervals of resurfacing can be increased by two to three years than the bituminous mixes with normal bitumen. This could result in savings though initial cost may be marginally higher. The layer of DBM below the wearing course should have stiffer binder such as VG 40 for highway of heavy traffic where air temperature may be 40°C or higher in summer.

**Table VII-1 Selection of Binder for Bituminous Mixes**

Maximum Average Air Temperature °C	Traffic (CVD)	Bituminous Course	Grade of Bitumen to be used
≤ 30°C	≤ 1500 commercial vehicles per day	BM, DBM and BC	VG 10 / VG 20
< 40°C	For all types of traffic	BM, DBM, SDBC and BC	VG 30
≥ 40°C	Heavy Loads, Expressways msa>30msa	DBM, SDBC, BC	VG 40 bitumen for wearing course as well as binder course, Modified bitumen may be used for the wearing course



## ANNEX-VIII

(Refer Clause 7.3.2.6)

### Resilient Modulus of Granular Materials

The guidelines for the resilient modulus of granular materials over subgrade recommend use of widely used Shell's equation given by Equation 7.1, which somewhat gives a conservative value. There is now increasing trend of using a more scientific approach for determination of resilient modulus,  $M_{Rgm}$ , by triaxial test since it is dependent upon the sum of the principal stresses as well as the octahedral stress as given below (14).

$$M_{Rgm} = K_1 \times \left[ \frac{\theta}{\rho} \right]^{K_2} \times \left[ \frac{\tau_{oct}}{\rho} + 1 \right]^{K_3} \quad \dots 7.1$$

$\theta$  = sum of the principal stresses

$$\tau_{oct} = \text{Octahedral stresses} = \frac{1}{\sqrt{2}} \left( \sqrt{(\sigma_1 - \sigma_2)^2 + (\sigma_2 - \sigma_3)^2 + (\sigma_3 - \sigma_1)^2} \right) \quad \dots \text{VIII-1}$$

$\sigma_1, \sigma_2$  and  $\sigma_3$  are the principal stresses in the granular layer

$\rho$  = atmospheric pressure = 100 kPa,  $K_1, K_2$  and  $K_3$  are experimental test constant. The constants of Equation VIII-1 are to be evaluated from repeated triaxial test as per the AASHTO – T307-99. The default values of the constants  $k_1, k_2$  and  $k_3$  may be taken as 300, 1.05 and -0.4 respectively (14) for crushed rocks meeting the gradation of Wet Mix Macadam as per MORTH specifications. A typical modulus value of 450 MPa over a cemented base may be taken for design. The suggested modulus of different types of granular layers over uncracked cemented layer is given in **Table-VIII-1(65)**.

**Table: VIII-1 Recommended Values of Resilient/Elastic Modulus of Aggregate Interlayer (48) Over Uncracked Cemented Layer**

S. No	Material Description	Modulus Over Uncracked Cemented Layer (MPa)	Recommended Modulus (MPa)	Poisson's Ratio	Remarks
(1)	High quality graded crushed rock (WMM)	250-1000	450	0.35	Stresses in pavement not very sensitive to minor variation Poisson ratio
(2)	Graded Crushed stone and soil binder; fines PI < 6	200-800	350	0.35	
(3)	Natural gravel; PI < 6, CBR > 80 Fines PI < 6	100-600	300	0.35	

## ANNEX-IX

(Refer Clause 3.1)

### Reclaimed Asphalt Pavement and Mix Design

Recycling of Reclaimed Asphalt Pavements (RAP) is required to be used for technical, economical, and environmental reasons. Use of RAP has been favoured all over the world over virgin materials in the light of the increasing cost of bitumen, the scarcity of quality aggregates, and the pressing need to preserve the environment. The use of RAP also decreases the amount of waste produced and helps to resolve the disposal problems of highway construction materials. Reclaimed Asphalt Pavements contain best quality aggregates and they can be effectively improved with foamed asphalt/bitumen emulsion along with fresh aggregates and crusher dust to impart necessary strength for a durable pavements. If only the surface layer is weathered or damaged, hot recycling can be an attractive proposition.

Several recycling techniques, such as hot mix plant recycling, hot in-place recycling, cold mix plant recycling, cold in-place recycling, and full depth reclamation, have evolved over the past 35 years. In-place recycling not only reduces the use of new materials but also reduces emissions, traffic, and energy associated with the transport and production of these materials.

Hot Mix Recycling is the most common method of recycling asphalt pavements in developed countries. It involves combining RAP with new or “virgin” aggregate, new asphalt binder, and recycling agents in a central hot mix plant to produce a recycled mix. The amount of RAP allowed in a recycled mix and guidelines as to where the recycled mix can be used in the pavement structure varies from agencies to agencies. Some routinely allow 15 per cent or less RAP while others permit larger amounts of RAP. Higher RAP concentrations require adjustments in mix design and binder selection. Agency’s recommendations and international guidelines such as those given by Asphalt Institutes may be used in different trials because of lack of experience in India.

Cold Mix Recycling is a method of recycling where RAP, new aggregate (if needed), and emulsified bitumen or foamed bitumen without the need for heat are mixed in a centrally located cold mix plant. Many old road alignment having thick bituminous layers are being abandoned in four and six laning projects and the entire RAP and aggregates can be salvaged by milling machine and reused in new construction. Even cement treated aggregates have been milled and reused in South Africa and China. Since the components of a cold mix plant are fairly portable, it can be assembled in satellite locations close to a project site. Cold recycled mix is hauled to the job site with conventional dump trucks or belly dump trucks. Placement and compaction of cold recycled mixes are done with the same conventional pavers and rollers used for hot mix asphalt construction. Cold recycled mixes are normally overlaid with hot mix asphalt or surface dressing (chip seal) depending on the anticipated traffic level for the finished pavement.

Cold recycling (21) also involves rehabilitation of the existing asphalt or granular road surface. The existing surface is pulverized and the material is mixed on the site with foamed bitumen or Bitumen emulsion. The process of in-situ recycling of distressed pavement using cold-mix technology is referred to as cold in-place recycling (CIPR). CIPR thus is a pavement rehabilitation measure that typically consists of the following operations, often all are carried out in one-pass of a recycling machine and badly distressed pavement is transformed into a stronger nice looking pavement

- (1) Milling the existing pavement layers upto a depth of 300 mm;
- (2) Treatment with bitumen emulsion or foamed bitumen, often in combination with addition of crusher dust, fresh aggregates if required, and a small percentage of active filler such as cement;
- (3) Adding compaction water; and
- (4) Repaving the mix.
- (5) Compaction

In a CIPR process as described above, the top bituminous layer (Reclaimed asphalt pavement) as well as a part or whole of the granular or stabilised base layer are recycled. The residual binder content added to the mineral aggregates in the process of CIPR is generally lower (<4 per cent) in comparison to hot bituminous mixtures. The recycled product is not used as final surfacing layer but used as base or sub-base layer. CIPR is an attractive alternative for highway rehabilitation operations because of its economic and environmental advantages. Major economic advantages involve the recycling of existing road surface aggregates and reduced haul requirements for incorporating new aggregates. In India, there are many regions where aggregates resources are limited or will be depleted in the near future. Aggregate haul in these regions is quite expensive. By recycling existing in-place road materials and providing additional strength with mixing of different emulsions or strengthening agents, new aggregates and bitumen requirements are reduced. In addition, impacts on adjacent haul roads are minimised or eliminated because of reduced new aggregate requirements. A major environmental advantage involved in the use of cold in-place recycling is that there is no requirement for heat during construction work. CIPR is an energy efficient process that does not produce harmful emissions and does not require the bituminous mixtures to be transported to an off-site plant. In addition, transportation of large amounts of aggregate are reduced and hence it is fuel efficient also.

## **Design for Bitumen Emulsion RAP Mixes**

### **Gradations of Aggregates**

The aggregates from RAP may not have the required gradation for a good mix. RAP alone has poor internal friction and its CBR may be as low as 30 though a fresh close graded aggregates may have CBR as high as 200. Addition of crusher dust containing particle size from 6 mm to 0.075 mm and fines passing 0.075 mm adds to angle of internal friction as well



as some cohesion to the RAP mixes. The crusher dust requirement can be 15 to 30 per cent and 1 per cent cement or lime or both by weight of dry aggregates helps in dispersion of the bitumen emulsion in the mix. Lime modifies the clay that may have contaminated the RAP may need re-crushing if they have lumped up during storage. If milled aggregates are from those of Bituminous Macadam, it may be open graded and some additional fresh aggregates may be necessary for the adjustment of gradation. The grading of the blend of RAP/fresh aggregates and crusher dust should meet the requirement shown in **Table IX-1** adopted from the South African Standard 'TG2 (64) CSIR Built Environment, Pretoria. The grading has been slightly adjusted to correspond to the sieve size designation in MORTH.

**Table IX-1 Gradation of RAP Mixes**

Sieve Size,mm	Per Cent Passing
45	100
37.5	87-100
26.6	77-100
19	66-99
13.2	67-87
4.74	33-50
2.36	25-47
0.60	12-27
0.3	8-21
0.075	2-9

Some RAP may be contaminated with clay which might have risen from the subgrade during the wet weather. Addition of 2 per cent lime would modify the clay and the mix becomes suitable for use.

### **Bitumen Emulsion Type**

Since the blend of RAP and crusher dust consists of plenty of fine particles, only slow setting emulsion (SS2) with minimum residual bitumen content of 60 per cent is recommended to prevent the emulsion from breaking during the mixing and construction.

### **Determination of Optimum Fluid Content**

A RAP bitumen emulsion mix can be compacted to maximum density only at optimum fluid content. Compaction tests are to be done at different fluid content to arrive at the optimum fluid content. Procedures given in Manual 14 'The design and Use of Granular Emulsion Mixes' Published by South African Bitumen and Tar association (SABITA) (7) and TG-2 of

South Africa (64) have been suggested for mix design. Users may adopt other methods of mix design given in 'Cold Mix Recycling' and 'Asphalt cold Mix Manual (MS-14)' Published by Asphalt Institute, USA.

**Step 1** Prepare a 50:50 blend of bitumen emulsion and water by volume. Water is added to bitumen emulsion and not the emulsion to water for dilution to prevent premature breaking. Compatibility for dilution may be checked.

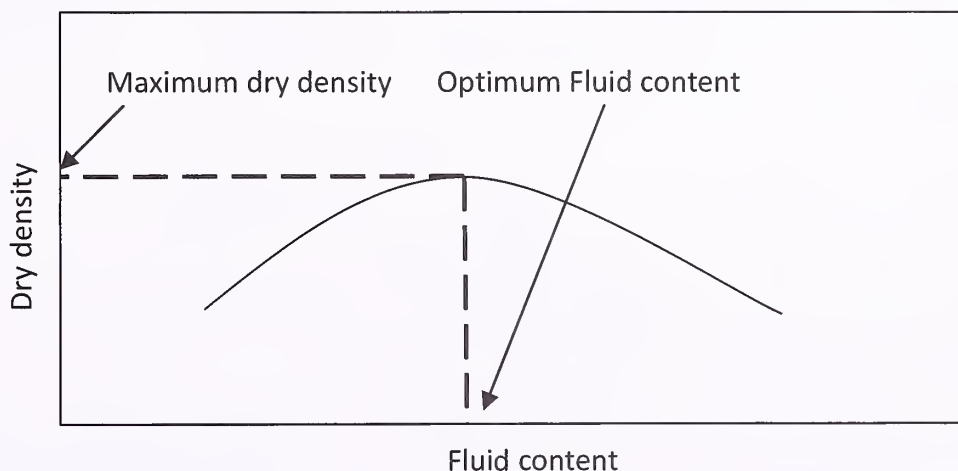
**Step 2** Actual water content of the blend of RAP, crusher dust and filler may be determined by oven drying and fluid increment of 1 per cent by weight of the blend may be added and thoroughly mixed. The mix is transferred to a standard 100 mm diameter Marshall mould and compacted by 75 blows on each face at ambient temperature. A minimum of three samples are cast at each fluid content.

**Step 3** Dry density should be computed at each fluid content as per the following:

$$D_{dd} = \frac{D_{bulk}}{1 + FC} \quad \dots IX-1$$

Where  $D_{dd}$  = Dry density in  $kg/m^3$ ,  $D_{bulk}$  = Bulk density in  $kg/m^3$ ,  $FC$  = Fluid content by dry weight of aggregates in decimal.

A plot is made for dry density vs. fluid content as shown below and maximum dry density and the corresponding optimum fluid content is determined. Optimum fluid content is necessary for the compaction of the RAP mixes to the maximum density.

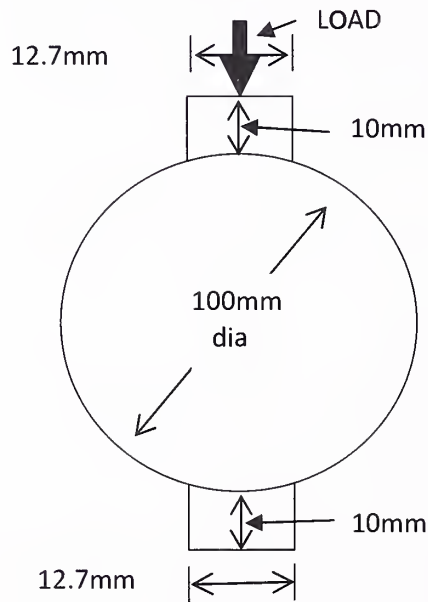


**Fig. IX-I Dry Density-Fluid Content Relation for Blended Rap Mix**

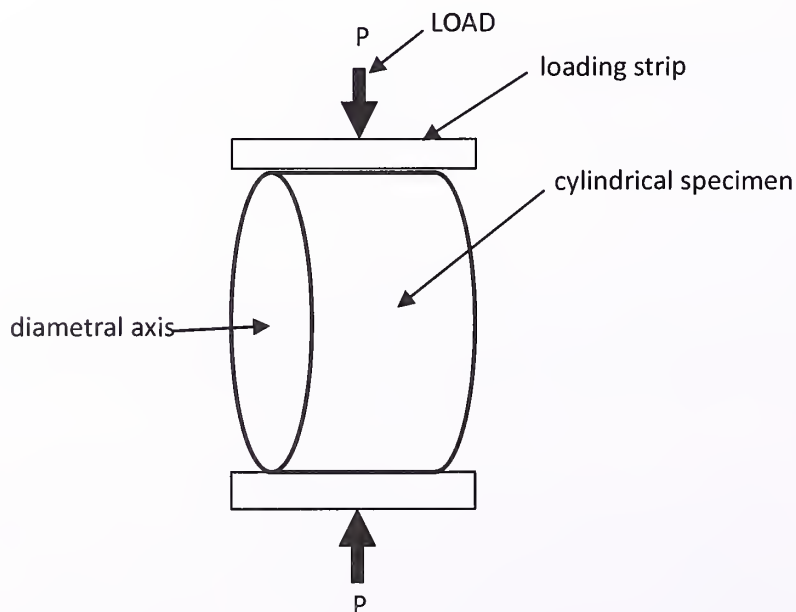
**Step 4** Marshall samples are prepared at different emulsion content starting from 3 per cent to 4 per cent by weight of the total mix in increment of 0.5 per cent. Additional water is added first and mixed then the bitumen emulsion is added and mixed again. The total fluid is close to the optimum. The sample is compacted in a Marshall mould by applying 75 blows on each face. Six samples are prepared at each fluid content.

**Step 5** The samples should be left in the mould for 24 hours and then placed in an oven for 72 hours at 40°C for curing after the extraction. The sample should be kept on a tray. Most of the moisture will be lost through evaporation.

**Step 6** Laboratory tests: Indirect tensile strength tests are to be carried out on dry samples in a standard Marshall loading frame which applies load at rate of nearly 50 mm per minute (50.8 mm per minute) and the maximum load is determined at 25°C. Three samples are also tested at 25°C after 24 hours of soaking in water.



**Fig. IX-II Marshall Samples of RAP 100 mm Diameter and 63 mm Long Under Indirect Tensile Test**





The loading strip is 12.7 mm wide and about 70 mm long to test samples of height up to 70 mm. A modified version of Marshall Test apparatus as per Fig. IX-II can be fabricated in a workshop. It is available commercially also.

$$\text{Indirect tensile strength, ITS (KPa)} = \frac{2000P}{\pi dh} \quad \dots \text{IX-2}$$

Where P = the maximum load in Newton, d = diameter of the sample, mm (may be close to 100 mm), h = height (thickness) of the sample, mm

If  $ITS_{\text{dry}}$  is greater than 400 kPa and  $ITS_{\text{wet}}$  is less than 50 per cent of the dry value, it is indicative of contamination with clay and 1 to 2 per cent lime may be necessary for modifying the plasticity of the clay (64). For 100 mm diameter samples, aggregates passing 26.5 mm sieve should be used for mix design. Effect of higher aggregate size is to increase the strength of the mixes.

The bitumen emulsion content satisfying the minimum strength requirement given in Table IX-II can be used for the mixing. Additional 1.5 to 2.5 per cent water may be added to the RAP mixes due to rapid evaporation of water in the hot weather since optimum fluid content is necessary for maximum compaction and strength gain. Within a few hours of laying of RAP mix, the top layer is able to stand the construction traffic due to loss of water on hot sunny days.

**Table IX-2 Minimum Strength Requirement of RAP Mixes**

Strength Test	Specimen diameter	Minimum strength, KPa
$ITS_{\text{dry}}$ , 25°C	100 mm	> 225 KPa
$ITS_{\text{wet}}$ , 25°C	100 mm	> 100 KPa

### Design of Foamed Bitumen RAP Mixes

Foamed bitumen is produced by injecting water into hot bitumen resulting in instantaneous foaming. The injected water turns into steam which is enclosed by finely divided bitumen bubbles. The foamed bitumen is injected into the cold RAP mixes or even fresh aggregates containing optimum amount of moisture for compaction. Such operation is highly specialised and agencies expertise may be used for the production and construction of RAP mixes or fresh aggregates treated with foamed bitumen. The gradation of aggregates can be same as that given in Table IX-1. The properties such as maximum expansion ratio (ER<sub>m</sub>), half-life (HL), type of binder used for foaming, viscosity of foamed bitumen etc play important role in quality of mix production.

**Mixing Moisture Content:** The Mixing Moisture Content (MMC) of a foamed bitumen mix is moisture content in the RAP mix when foamed bitumen is injected which is practically same as Compaction Moisture Content (CMC) required for maximum compaction. A few trials are needed to determine the MMC. Methods of sample preparation and curing are same as

that of the bitumen emulsion mixes. Mixes are prepared with different amount of foamed bitumen and that which meets the minimum strength requirement in dry and wet condition is adopted for production of foamed mixes. 75 blow compaction on each face of 100 mm diameter Marshall samples is adopted for sample preparation. Test procedures and strength requirement are also identical as given earlier for bitumen emulsion mixes. Foamed asphalt mixes need less water and cure faster but in hot weather prevalent in most parts of India, emulsion mixes also may cure fast due to migration of moisture from high vapour pressure region in the interior to low vapour pressure region on the surface. Recommendation of TG-2 published by Asphalt Academy, South Africa may be used.

One of the advantages of the cold mixes are that they can be stock piled and used later when needed. Wet weather damage of RAP due to lack of an impermeable wearing course as well as due to poor drainage can be a serious problem.

**Table-IX-3 Recommended Values of Resilient Modulus and Poisson Ratio of RAP Mixes**

Material	Recommended Resilient Modulus (MPa) and Poisson's Ratio	Range of Moduli (MPa)	Remarks
Bitumen Emulsion/ Foamed bitumen treated RAP	600	600-1200	Higher modulus of RAP is not sustainable due to heavy load. Wet water damage can be a serious problem hence higher modulus is not recommended These values can be revised based on FWD test on in-service pavements
Bitumen emulsion/ Foamed bitumen treated aggregates	600	600-1200	

A modulus of 600 MPa is recommended for RAP mixes for pavement design considering the variability of RAP mixes though laboratory tests under controlled conditions give modulus values ranging from 600-1200 MPa under a haversine loading pulse of duration 0.1 seconds with a rest period of 0.9 seconds. FWD tests on in-service pavements having RAP mixes can help the designers to determine the in situ modulus values over a period of time and compute the remaining life of the pavement. RAP mixes keep on gaining strength with loss of moisture but high modulus determined in the laboratory is not sustainable due to tensile stresses caused by heavy traffic on highway in India.

Fines of the RAP mixes captures most of the bitumen both for bitumen emulsion and foamed bitumen mixes and particulate nature of the RAP is maintained. Its behaviour over granular and cemented sub-bases is different due to different level of confinement from the top and the bottom.



## ANNEX-X

(Refer Clause 3.1)

### Pavement Layers with Chemical Stabilized Materials

**X-1:** Chemically stabilized soils and aggregates may include all kinds of stabilization such as cement, lime, lime-flyash, or their combination, proprietary chemical stabilisers, enzymes, polymers and any other stabilizer provided these meet the strength and durability requirements. While cement, lime, lime-flyash stabilized materials are well known for their strength, performance and durability, the commercially produced stabilizers should meet the additional requirements of leachability and concentration of heavy metals. Where stabilized materials are used in the pavement, only mechanized method of construction for laying and compaction should be used. The equipment should be capable of administering the design doses of stabilizer and quantity of water and producing a uniform and homogeneous mix. Such materials are also termed as cemented or cementitious materials.

**X-2:** IRC:SP:89-2010 Guidelines for Soil and Granular Material Stabilization using Cement, Lime & Fly Ash' has very comprehensively described the entire process of stabilization. High strength chemically stabilized layer having a 7-day unconfined strength of 6-12 MPa given Table 8 of IRC:SP:89-2010 is not recommended because of wide shrinkage and thermal cracks that may occur during the service. Cementitious materials having lower strength can be used in bases and sub-bases. Since a cementitious base is required to act as an important load bearing layer, a minimum strength of 4.5 MPa for bases of cement treated aggregate at seven days is necessary for long term durability as measured by Wetting and drying/freezing and thawing tests (BIS: 4332 (Part IV) - 1968). Specimens having a strength of 5 MPa and above are generally stable under durability tests. Cement stabilised aggregate specimens should be stored in a moist curing room/curing chamber undisturbed for seven days before tests. Modulus of rupture of cementitious bases may be taken as 20 per cent of the 28 day UCS (MEPDG) for flexure strength evaluation.

**X-3:** Lime-Soil and Lime-flyash-aggregate mixes develop strength at a slow rate and strength for their acceptability should be determined at 28 days. These slow setting stabilizers develop fine cracks unlike cement treated materials in which the rate of strength gain is high. These binders need less water for compaction which indirectly reduces shrinkage also. Long term strength of lime-soil or lime-flyash-soil mixtures can be determined by curing sealed samples at 40°C (ASTM D5102-09 'Standard Test Methods for Unconfined Compressive Strength of Compacted Soil-Lime-Mixtures'). Accelerated curing may be use to provide a correlation between between normal and accelerated curing strengths for the material-binder combination. Three day curing of lime of lime-flyas soil at 50°C is found to be equivalent to about 33 to 38 days of moist curing at ambient temperature of about 30°C (16). Some typical values of unconfined compressive strength and modulus of rupture of lime-flyash concrete



suitable for cemented bases extracted from IRC:SP:20-2002 'Rural Road Manual' are given below:

Extracted from IRC:SP:20-2002 'Rural Road Manual'

The proportions may vary depending upon the quality of materials and laboratory tests are required to be done prior to construction to ensure that the materials have the minimum strength. Different trials are necessary to arrive at a good mix proportion for a base and a sub-base. Construction procedure is explained in IRC:SP:20-2002. **Table X-1** indicates that even for lime-fly ash stabilized materials, flexural strength can be about 20 per cent of the UCS. Published literature also (16) shows that flexural strength may be as high as 35 to 40 per cent of the UCS of lime or lime-flyash stabilized soil. The recommendation of MEPDG (3) taking the flexural strength as 20 per cent of the UCS is very reasonable if laboratory data is not available. Long term strength gain for slow setting stabilizers can be considered in design.

**Table X-1 Expected Strength of Lime-Flyash Concrete Mixes**

S.No	Proportion of Lime: Fly Ash and Coarse Aggregate by Weight	Water Content, per cent by Weight of Mix	28 Day Strength in MPa	
			UCS	MR
1	1:2.0:2.5:5.25	10.0	6.9	1.48
2	1:2.0:2.7:6.3	11.0	7.5	1.48
3	1:1.5:2.25:5.25	9.7	7.5	1.48

**X-4:** Laboratory tests: A number of laboratory tests such as flexure tests, direct tension test, longitudinal resonant frequency test, indirect tensile strength test, direct compression test etc. can be used to measure elastic modulus of cementitious material. Unconfined compression tests give high values of modulus. AUSTRROADS recommend flexure load test since this is considered to be closer to stress/strain in the cemented base layer caused by traffic loading. Relation between UCS and elastic modulus was recommended (14) as

$$E \text{ (cemented base)} = k \times \text{UCS} \quad \dots \text{X-1}$$

UCS = Unconfined strength at 28 days, MPa; k = 1000 to 1250.

E value of the cemented bases containing 4 to 6 per cent Ordinary Portland and slag or Pozzolanic cements is recommended as 5000 MPa. If field evaluation by FWD indicates higher modulus, fresh estimate of pavement life can be made.

Poisson's ratio of the cemented layer may vary from 0.2 to 0.25. A value of 0.25 may be adopted. Stresses are not very sensitive to Poisson's ratio.

Cemented granular sub-base may have cement from 2 to 4 per cent to get a 7-day strength of 1.5 to 3.0 MPa. Its modulus as determined in laboratory may range from 2000 MPa to 3000 MPa. Since it forms the platform for the construction traffic, it cracks and cannot retain the initial modulus. A value of 600 MPa is recommended and its fatigue behaviour is not considered because of cracks. If the stabilized soil sub-bases have 7-day UCS values in

the range 0.75 to 1.5 MPa, the recommended E value for design is 400 MPa. Field tests by FWD should be routinely done to collect data for obtaining pavement design parameters. Cement requirement for a given strength is much higher for soils than for granular materials. For the commercially available propriety cementing materials, the binder contents have to be determined from laboratory tests to meet the strength requirement.

**X-5:** Cemented bases should be compacted in a single layer to a maximum compacted thickness of 200 mm. Layers laid at different times may not have the strength because of lack of interface bond unless special care is taken.

**X-6:** After the construction, curing as recommended in IRC:SP:89-2010 must be done immediately to aid in development of strength and prevent drying shrinkage. Spraying of bitumen emulsion is a very effective method of curing. Exposing the compacted layer to sun damages the stabilised layer and it does not develop strengths as intended.

**X-7:** Cemented layers normally develop transverse and longitudinal cracks due to shrinkage and thermal stresses during hydration and during the service life. Hence a layer of Stress Absorbing Membrane Interlayer (SAMI) of elastomeric modified binder (AUSTROADS 2004) is to be provided over the cemented base to resist reflection cracking. The rate of spread of the binder is about 2 litres/m<sup>2</sup> followed by light coating of aggregates of size 10 mm to prevent pick-up of the binder by the wheels of construction machinery. Geotextile seal and many other commercially available synthetic products available commercially have the promise to retard crack propagation in the bituminous layer. SAMI is not very effective if the crack opening is more than 3 mm.

**X-8:** Another method of arresting the cracks from propagating to the upper bituminous layer is to provide an interlayer of good quality aggregates between the bituminous layer and the cemented base. The aggregate layer should extend beyond the cemented base by about 0.5 m so that moisture, if any, travels down to the porous sub-base. Wet Mix Macadam (WMM) meeting the IRC/MORTH specification can form a good aggregate interlayer. Being sandwiched between two stiff layers, the aggregate behaves as layer of high modulus under heavy load while its modulus is lower when lighter loads act. Priming and tack coating are required before laying of the bituminous layer. Use of 1 to 2 per cent bitumen emulsion in WMM is needed only when the construction traffic is likely to deform the compacted WMM requiring regrading. It does not improve the crack resistance of the aggregate layer. Thickness of 75 mm to 150 mm has been used for the inter layer by different organisations. The Guidelines propose a thickness of 100 mm.

**X-9:** Behaviour of cemented base after traffic associated cracking: The cemented layers may get numerous cracks due to fatigue cracking and its modulus may be reduced drastically from 5000 MPa to 500 MPa. Falling Weight Deflectometer can be a good tool to examine the condition of the cemented base at any time during its service life. The bituminous layer has little tensile strain before cracking of the cemented base but the value becomes very high after the cracking of the base and fatigue failure of the bituminous layer also is imminent. If



the thickness of the bituminous layer is higher 175 mm (14), the bituminous layer also has considerable remaining life and the total life of the pavement is the sum of the fatigue life of the cemented layer and that of the bituminous layer. If the sum of the thickness of bituminous layer and 75 per cent of the thickness of aggregate interlayer is greater than 175 mm (14), the pavement life is again equal to the fatigue lives of the cemented and that of the bituminous layers.

**X-10:** Maximum size of the aggregate of the granular base and sub-base should be 53 mm for obtaining a homogeneous mass in mechanised construction. Close graded granular sub-base of MORTH can be used in the construction of cemented bases and sub-bases while coarse graded granular sub-base with percent passing 0.075 mm sieve less than 2 per cent can be used as a porous cemented drainage layer laid above the coarse graded cemented sub-base. Grading 4 of **Table V-I** can also be used.

**X-11:** Procedure for the mix design method for cementitious granular bases and sub-bases can be same as adopted for Dry Lean Concrete (MORTH) except that the cementitious stabilizer content is much lower due to low strength requirement. Optimum moisture content has to be determined by trial. Since maximum size of aggregates can be 53 mm, 150 mm cubes have to be made at different moisture content and compacted by vibratory hammer with square plates. Details are given in MORTH Specifications for determination of optimum moisture content, method of curing and evaluation of strength. The properties of cementitious bases and sub-bases are given in **Table X-2**.

**X-12:** For stabilized soils, even 50 mm diameter, 100 mm high samples can be used for UCS after curing. Beam size can be 50 mm x 50 mm x 300 mm for flexure tests after curing. Field condition may be simulated during the curing.

**X-13:** If the soil is modified by addition of small percentage of lime/cement/other stabilizers, CBR tests can be done to evaluate the quality of the modified soil. If the cement content is 2 per cent or higher, unconfined compressive strength should be determined to determine the strength of the stabilized soil.



Table X-2 Properties of Cementitious Bases and Sub-bases

S.No	Description	UCS(MPa)	Modulus of Rupture	Elastic Modulus, E (MPa) and Poisson Ratio	Range of Modulus	Remarks
(1)	Granular material for base layer	4.5-7.0 at 7 days for cement (28 days for lime-flyash), determined by test on 150 mm cube (IRC:SP:89:2010) Cube shall be made as per IS-516 except that they shall be compacted by the vibratory hammer at OMC as per MORTH specifications for DLC	determined by third point bending test at 28 days, as per IS-516 except that the sample should be compacted by the vibratory hammer with rectangular foot at OMC, (20 per cent of the UCS at 28 days may be taken as default value for Modulus of Rupture)	E = 1000 * UCS (MPa) at 28 days (Austroads) Adopted value E=5000, $\mu=0.25$	Initial Modulus can be in the range 3000-14000 MPa(65). Austroads recommends flexural modulus of 5000 MPa for pavement design assuming 28 day UCS value of 5 MPa	Material must pass durability test as prescribed in IRC:SP:89:2010 for long term durability. Loss of Weight in 12 cycles of wetting-drying or freeze thaw not more than 14 per cent
(2)	Granular material for sub-base	1.5-3.0 at 7 days for cement (28 days for lime-flyash), determined by test on 150 mm cube (IRC:SP:89:2010)	—	E = 600, $\mu = 0.25$	Initial Modulus can be in the range 2000-10000 MPa, it may be reduced to 500-800 MPa due to cracking by the construction traffic(49)	—

(3)	Granular material for sub-base (Design traffic <10 msa)	0.75-1.5 at 7 days for cement (28 days for lime-flyash), determined by test on 150 mm cube (IRC:SP:89:2010)	—	E = 400, $\mu = 0.25$	Initial Modulus can be in the range 500-7000 MPa, it may be reduced to 400-600 MPa due to cracking by the construction traffic (65)	—
(4)	Chemically stabilized soil for sub-base	UCS: 0.75 to 1.5 MPa at 7 days for cement (28 days for lime flyash) UCS is to be done cylindrical specimen 50 mm dia 100 mm height. (ASTM D-5102-09)	—	E = 400 MPa	the range of the moduli depends on the soil type	Quantity of chemical stabilizer requirement is much larger than that of the granular material for the same strength. Generally not recommended for heavy traffic in wet area
(5)	Chemically stabilized soil for base	UCS: 4.5 to 7 MPa at 7 days for cement (28 days for lime flyash) UCS is to be done on cylindrical specimen 50 mm dia 100 mm height.	$M_R = 0.7$ MPa (MEPDG) for UCS value of 5.2 MPa for soil cement. ASTM-D1635-06 Standard Test Method for Flexural Strength of Soil-Cement Using Simple Beam with Third-Point Loading	E = 3500 MPa is recommend by MEPDG for soil cement base value is to be determined from the flexural test by measuring load and deflection after 28 days of curing		

## ANNEX-XI

(Refer Clause 3.1)

### Roads Constructed in India with Alternate Materials

Following successful trials among many others for cemented bases, sub-bases, cold and Hot RAP mixes were done in different places in India

#### Cemented (Hydraulic Binders) Layers

Cemented bases with SAMI using modified bitumen topped with DBM and BC performed well in trial sections Krishnagiri-Topurghat Road Project (Tamil Nadu). It was designed for 150 msa traffic. Periodical inspections indicated fine transverse cracks at about 25 m spacing after three years and riding quality was maintained within the acceptable limits. Light spray of diluted bitumen emulsion across the fine cracks before the monsoon was done as a preventing maintenance to preclude any entry of water during the monsoon. FWD deflection studies also indicated low deflections. Following trials has been successfully carried out.

- (1) Ahmedabad-Udaipur (NH8) had a cement treated layer below the WMM
- (2) Cement treated base was used in Jamnagar refinery in Gujarat for heavy commercial vehicles
- (3) Ahmedabad-Vadodara expressway had a cement treated layer below the WMM
- (4) Achad-Manor in Maharashtra
- (5) Chitradurga haul road in Karnataka. The trial pavement was able to sustain heavy haul road traffic without distress. FWD test also was done to verify the design modulus
- (6) Durbal-Hanjik Road in Srinagar

#### RAP Mixes were Successfully Used in Following Places

- (1) NH-6 in West Bengal: Cold in-situ recycling of Reclaimed Asphalt Pavement was done in 2004 and pavement evaluation before and after the recycling showed marked improvement in the strength of the pavement. Pavement performance is evaluated by FWD and modulus of the RAP improved considerably. (21)
- (2) Plant recycling was done in Kolkata on a heavily trafficked main road (Prince Anwershah Road) using foamed bitumen. Pavements were evaluated both before milling the bituminous surface and after the construction of the foamed bituminous base and Semi Dense Carpet wearing course. The road was found to be sound even after the two heavy monsoons along with occasional water logging
- (3) Hot in-situ recycling was done on Mehraulli-Badarpur Road under Delhi P.W.D.



## REFERENCES

- (1) AASHTO T307-99 (2003), Standard Method of Test for Determining the Resilient Modulus of Soils and Aggregate Materials.
- (2) AASHTO (1993) Guide for Design of Pavement Structures, American Association of State Highway and Transportation Officials, Washington DC.
- (3) AASHTO 2002 (2004), 'Guide for Mechanistic-Empirical Design of New and Rehabilitated Pavement' MEPDG, NCHRP, TRB, Final Report.
- (4) Amaranatha Reddy, M., Sudhakar Reddy, K. and Pandey B.B.(2001), 'Design CBR of Subgrade for Flexible Pavements', IRC Highway Research Bulletin No.64, June 2001 pp. 61-69.
- (5) Asphalt Institute (2003), 'Performance Graded Asphalt Binder-Specification and Testing, Superpave Series No.1(SP-1).
- (6) Asphalt Institute "Cold Mix Recycling".
- (7) Asphalt Institute "Asphalt Cold Mix Manual" MS-14.
- (8) Asphalt Institute (1981), 'Thickness Design–Asphalt Pavement Highways and Streets, Manual Series No.1.
- (9) ASTM D1635 - 00 (2006) "Standard Test Method for Flexural Strength of Soil-Cement Using Simple Beam with Third-Point Loading".
- (10) ASTM D5102-09 "Standard Test Method for Unconfined Compressive Strength of Compacted Soil-Lime Mixtures".
- (11) ASTM-D6951-09, Standard Test Method for Use of the Dynamic Cone Penetrometer in Shallow Pavement Applications.
- (12) ASTM D7369-09 "Standard Test Method for Determining the Resilient Modulus of Bituminous Mixtures by Indirect Tension Test".
- (13) ASTM D 7460-10) "Standard Test Method for Determining Fatigue Failure of Compacted Asphalt Concrete Subjected to Repeated Flexural Bending".
- (14) AUSTROADS (2004), 'Pavement Design-A Guide to Structural Design of Road Pavements', Sydney.

- (15) Bhattacharya, P.G. and Pandey, B.B. ('Flexural Fatigue Strength of Lime-laterite Soil Mixtures') Transportation Research Record 1986, No 1089, pp.86-91.
- (16) Bhattacharya, P.G. and Pandey, B.B. 'Study of Strength and Curing of Lime—Stabilised Laterite Soil-Plain and Fibre-Reinforced' Indian Roads Congress, HRB Bulletin No. 24, 1986, pp 1-26'.
- (17) BIS: 4332 (Part IV) – (1968, Reaffirmed in 2010), 'Methods of Test for Stabilized Soils: Wetting and Drying, Freezing and Thawing Tests for Compacted Soil-Cement Mixtures.
- (18) Brown, S.F., Brunton, J.M., and Pell, P.S., "The Development and Implementation of Analytical Pavement Design for British Conditions, proc. of 5th Int. Conf. on stuct. Des of Asph. Pavements, Vol. I, 1982, pp. 81-87.
- (19) Brunton, J.M., Brown, S.F., and Pell, P.S., "Development to Nottingham Analytical Design Method for Asphalt Pavements, Proc. of 6th Int. Conf. on Struct. Des. of Asph. Pavements, Vol. I, 1987, pp. 366-377.
- (20) Monismith Carl, Long, Fenella and Harvey, John, (2001), 'California's Interstate-710 Rehabilitation: Mix and Structural Section Designs, Construction Specifications' Proc. Association of Asphalt Paving Technologists, Vol. 70, pp. 762-802.
- (21) Kumar, C.Kishor, Kumar, S.N.V. Amar, Reddy, M.A., Reddy, K. Sudhakar, "Investigation of Cold-in-place Recycling Mixes in India", International Journal of Pavement Engineering, 1, 2007, pp 1-10.
- (22) Draft TRH4 (1996), 'Structural Design of Flexural Pavements for Interurban and Rural Roads', Pretoria, South Africa.
- (23) Flaherty, C.A.O, "HIGHWAYS", 4th Edition, 2004, Butterworh-Heinemann.
- (24) Harvey, J. T., Monismith, C.L., Bejarano, M., Tsai, B.W., and Kannekanti, V., 'Long-Life AC Pavements: A Discussion of Design and Construction Criteria based on California Experience' International Conference on Design of Long Lasting Asphalt Pavements, Aubun, Alabama, USA, PP. 284-333.
- (25) <http://www.irc.org.in/ENU/knowledge/research/Pages/MORTHResearchReport.aspx>
- (26) [http://www.tpub.com/content/engineering/14070/css/14070\\_428.htm](http://www.tpub.com/content/engineering/14070/css/14070_428.htm)

- (27) [http://www.ohio.edu/icpp/upload/Fatigue per cent20Characteristics per cent20of per cent20RBB-Carpenter.pdf](http://www.ohio.edu/icpp/upload/Fatigue%20Characteristics%20of%20RBB-Carpenter.pdf)
- (28) Huang, Y.H. (2004), 'Pavement Analysis and Design' 2nd Ed. Pearson/education.
- (29) IRC:111-2009 "Specifications for Dense Graded Bituminous Mixes".
- (30) IRC:SP:89-2010 Guidelines for Soil and Granular Material Stabilisation Using Cement, Lime & Fly Ash.
- (31) IRC: 81-1997 "Guidelines for Strengthening of Flexible Pavements Using Benkelman Beam Deflection Technique".
- (32) IRC:SP:79-2008, "Tentative Specifications for Stone Matrix Asphalt".
- (33) IRC:SP:42 1994, "Guidelines for road drainage, Indian Roads Congress".
- (34) IRC:SP:50-1997, "Guidelines for Urban Drainage", Indian Roads Congress.
- (35) IRC:SP:72-2007, 'Guidelines for the Design of Flexible Pavements for Low Volume Rural Roads'.
- (36) IS:2720, Part 16 (1987, Reaffirmed 2007) "Methods of Test for Soils: Laboratory Determination of CBR".
- (37) Jack Van Kirk and Glynn Holleran (2000), 'Reduced Thickness Asphalt Rubber Concrete', 1st. Int. Conf. World of Pavements, Sydney, Australia.
- (38) Krishna, M. (2010), 'Investigations on Long Life Bituminous Pavements' M.Tech. thesis, IIT Kharagpur.
- (39) Kumar, S.S., Sridhar, R., Reddy, K.S. and Bose, S. (2008), 'Analytical Investigation on the Influence of Loading and Temperature on Top-Down Cracking in Bituminous Layers', J. Indian Roads Congress, Vol. 69-1, pp.71-77.
- (40) Lister, N.W. and Powell, W.D. (1987), Design Practice of Bituminous Pavements in United Kingdom, Proc. of 6th Int. Conf. on Struct. Des. of Asphalt Pavements, Vol 1.
- (41) Metcalf J.B., Li, Y., Romanoschi, S.A. and Rasoulia, M. (1999), "The Performance and Failure Modes of Louisiana Asphalt Pavements with Soil Cement Bases under Full Scale Accelerated Loading", Transportation Research Record 1673, pp. 9-15.
- (42) Monismith, C.L., Harvey, J. T., Bressette, T., Suszko, C. and Martin, J.S., 'The I-710 Freeway Rehabilitation Project: Mix and Structural Section Design, Construction Considerations, and Lessons Learned', International Conference on Design of Long Lasting Asphalt Pavements, Auburn, Alabama, USA, pp. 217-262.



- (43) Lister, N.W. and Powell, W.D. 'Design Practice for Bitumen Pavements in the United Kingdom', Proceedings of 611 International Conference on Structural Design of Asphalt Pavements, Volume 1, 1987.
- (44) Palit, S.K., Reddy K. Sudhakar and Pandey, B.B. (2004) 'Laboratory Evaluation of Crumb Modified Asphalt Mixes' J. Materials in Civil Engineering, ASCE, Vol. 14, No.1, pp. 527-530.
- (45) Panda, M. and Mazumdar, M. (1999), 'Utilisation of Reclaimed Polythene in Paving Mixes' J. Materials in Civil Engineering, ASCE, Vol. 14, No. 6, pp 527-530.
- (46) Pandey, B.B. (2008), 'Improved Design of Flexible Pavements' Highway Research Journal, Vol. 1, No. 2 Special issue, Indian Roads Congress, pp 43-53.
- (47) Pavan Kumar. G, (2009), "Effect of Binders on Fatigue Life of Bituminous Mixes", M. Tech Thesis, IIT Kharagpur.
- (48) Philips, S.D. 1994, 'Theoretical Analysis of Labour-Intensive Construction of Water Bound Macadam Roads', Ph.D. dissertation, University of the Witwatersrand, Johansnesburg.
- (49) Rao, S. K., Das, J.K. and Roychowdhury, P. (2007), Asphalt Mix Design – Refusal Density Approach for Heavily Trafficked Roads, Journal of Indian Roads Congress, Vol. 68, No. 1, pp. 53-64.
- (50) Rajsekhar, R. ( 2011), 'Mechanistic Design of Bituminous Pavements with Different Types of Bases' M.Tech. Thesis, IIT Kharagpur.
- (51) Reddy, K.S. (2007), Investigation of Rutting Failure in Some Sections of National Highway-2 Between KM. 317 and KM. 65, Transportation Engineering Section, Department of Civil Engineering, IIT Kharagpur, India.
- (52) Reddy, N.M. and Pandey, B.B. (2010), 'Bituminous Pavement with Cementitious Base' Highway Research Journal, Indian Roads Congress, Vol.3, No. 2, pp. 23-29.
- (53) Reddy, K.S. (2005), 'Top Down Cracking of Bituminous Concrete on Godhra-Shamlajee Section of SH-5 in Gujarat.
- (54) Research Scheme R-56 'Analytical Design of Flexible Pavements' Final Report submitted to the Ministry of Surface Transport (Roads Wing), March 1999, Civil Engineering Department, Indian Institute of Technology, Kharagpur, West Bengal.

- (55) Research Scheme (R-54 MORTH, 2000), Use of Rubber and Polymer Modified Bitumen in Bituminous Road Construction, by Central Road Research Institute.
- (56) Research Scheme R-81 (2003), 'Structural Evaluation of Pavements using Falling Weight Deflectometer', Indian Institute of Technology, Kharagpur and the Ministry of Road Transport and Highways.
- (57) R-6: Development of Methods, such as, Benkelman Beam Method for Evaluation of Structural Capacity of Existing Flexible Pavements and also for Estimation and Design of Overlays for Strengthening of Weak Pavements, Research Scheme R-6 of Ministry of Surface Transport (Roads Wing), Final Report submitted by Central Road Research Institute, New Delhi 1995.
- (58) R-19: Pavement Performance Study of Existing Pavement Sections, Final Report, Volume-2, submitted to the Ministry of Surface Transport (Roads Wing), Central Road Research Institute, New Delhi 1994.
- (59) SABITA (2008), "Updating Bituminous Stabilized Materials Guidelines: Mix Design Report, Phase II", Dept. of Transport and Public works: Gauteng, South Africa.
- (60) Shell (1978), "Shell Pavement Design Manual-Asphalt Pavements and Overlays for Road Traffic", Shell International Petroleum, London.
- (61) Sinha, V.K, Singh, H.N. and Shekhar, S. (2007), 'Rutting in Flexible Pavement-A Case Study', J. of Indian Roads Congress, Vol. 68-3, pp. 177-191.
- (62) Specifications for Road and Bridge Works (fourth Revision), 2001, Ministry of Surface Transport (Roads Wing), Published by Indian Roads Congress, New Delhi.
- (63) Sridhar, R. (2009), 'Top-Down Cracking in Bituminous Pavements' Ph.D. Thesis (unpublished), IIT Kharagpur.
- (64) TG2 (Asphalt Academy) A Guideline for the Design and Construction of Bitumen Emulsion and Foamed Emulsion Stabilised materials' CSIR Built Environment, Pretoria.
- (65) These, H.L., M de Beer and Rust, F.C. (1996) 'Overview of the South African Mechanistic pavement Design Analysis Method' TRB, January, 1996, Washinton, D.C.
- (66) These, H.L., 'TRH4 Revision 1995, Mechanistic design of the Pavement structures in the TRH4 Pavement Design Catalogue' Division for Road Transport Technology, CSIR, Pretoria, South Africa.

- (67) Thomson, M.R. and Carpenter, S.H. (2004), 'Design Principles for Long Lasting HMA Pavements', International Conference on Design of Long Lasting Asphalt Pavements, Auburn, Alabama, USA, pp. 365-384.
- (68) Watanatada T. et al, 'Vehicle Speeds and Operating Costs- Model for road Planning and Management', World Bank Publication, 1987.
- (69) Witczak, M.W. and Mirza, M.A. (1999) 'Comparison and Assessment of Fatigue of Elvaloy Modified Asphalt Mixture with Conventional Asphalt Mixtures' A Technical Report prepared for Dupont, Delaware, University of Maryland. USA. witczak161.
- (70) IRC:9-1972 "Traffic Census on Non-Urban Roads".
- (71) IRC:SP:84-2009 "Manual for Specifications & Standards for Four Laning of Highways Through Public Private Partnership".
-







**(The Official amendments to this document would be published by the IRC in its periodical, 'Indian Highways' which shall be considered as effective and as part of the code/guidelines/manual, etc. from the date specified therein)**